



Blanc

 graypants®





Here at Graypants we are a team of problem solvers, designing products, architecture and bold installations with a focus on imagination, natural materials and quality craftsmanship. Through beautiful and practical design, we look to elevate the world around us in ways that can be appreciated for a lifetime. Anchored in Seattle and Amsterdam, our work expands globally including collaborations and custom designs for leading companies worldwide, transforming space with light.

Dream big.
Scribble often.
Make thoughtfully.

Creating a place to gather, Wick is designed to be a companion, to join in adventures and create togetherness and ambiance everywhere. Wick is a call from our past to the future; it's the opportunity to mindfully light the present.

Wick

We no longer rely on candles to keep us out of the dark, but candlelight has always filled our lives, setting the stage for warm dinners and intimate evenings.

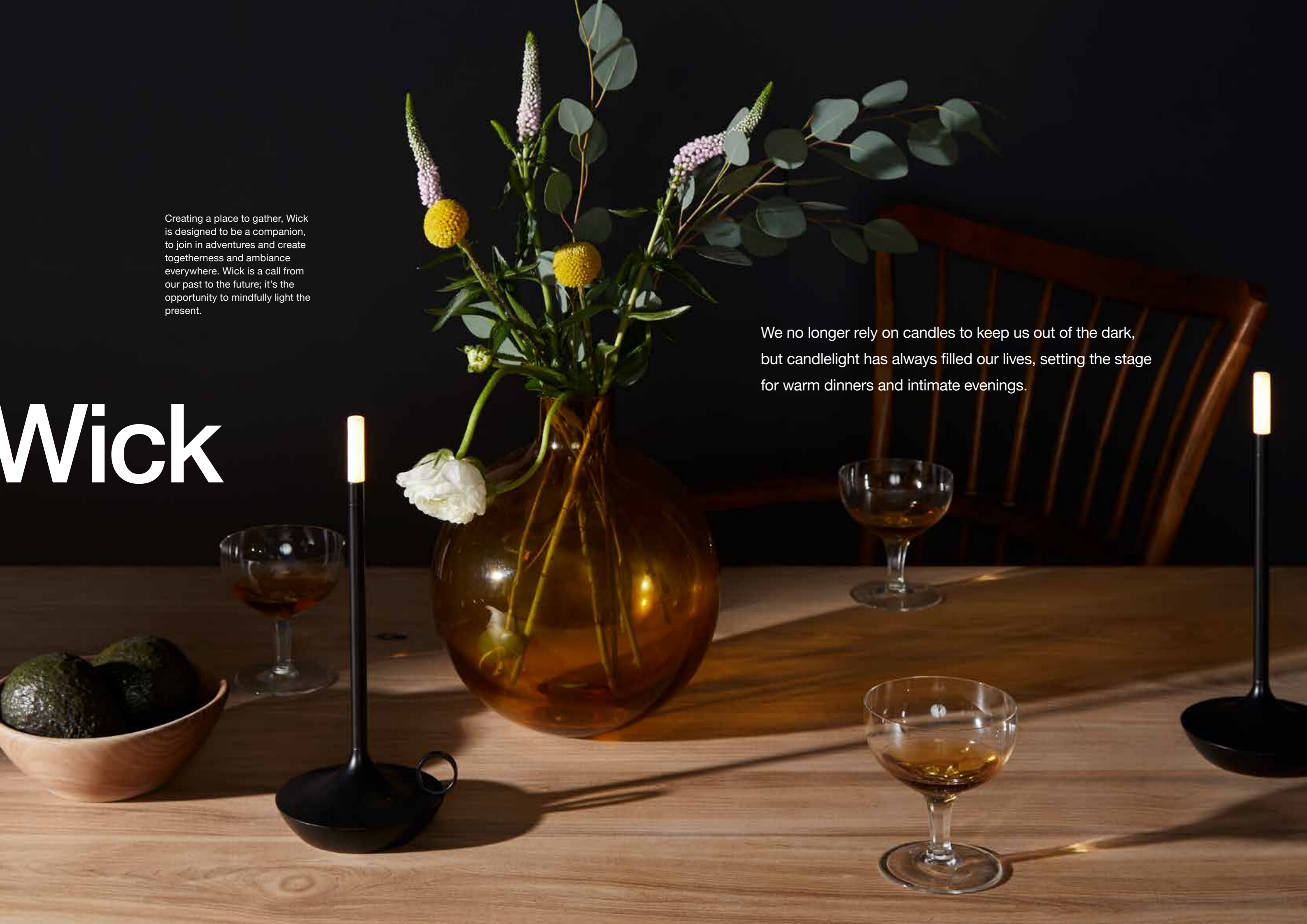



Wick

Wick is designed with the belief that light is meant to be shared. As a portable LED table lamp, Wick is candlelight for the modern era – safe, versatile, and classic.

Activate Wick using a touch sensor, and toggle between four brightness settings including a gentle, flickering candle mode. Depending on the brightness setting, Wick stays lit from 7 to 70 hours.

Combining the romance of a candle with the utility of a flashlight, Wick is at home in a variety of contexts, from your bedside table and backyard patio, to restaurants and event spaces.

Colors

Brass
Graphite
White
Black

Dimensions

Wick



Ø 4.7, H 10.2 (in)
Ø 12, H 26 (cm)







Levity



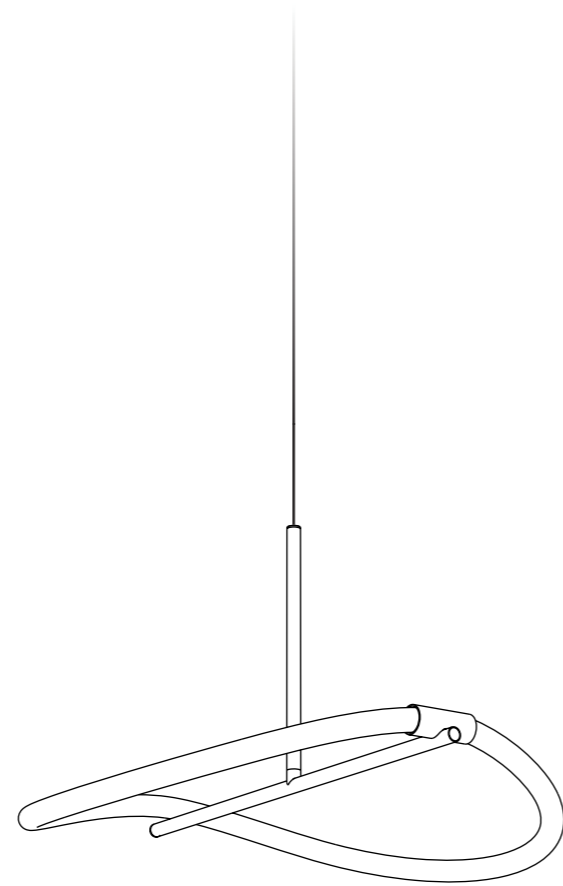

Pendant

Levity

For the Levity series, we partnered with Netherlands-based Studio Truly Truly, a design studio who frame their work as a manifesto: Make things properly, honestly and artfully. Studio Truly Truly focuses on designing products that combine function with sensuality. Levity is a series of minimal and poetic flexible lights, combining a rigid metal frame with a draped textile shade.

Feelings of both lightness and gravity are prompted by the Levity loop's elegant, draped forms.

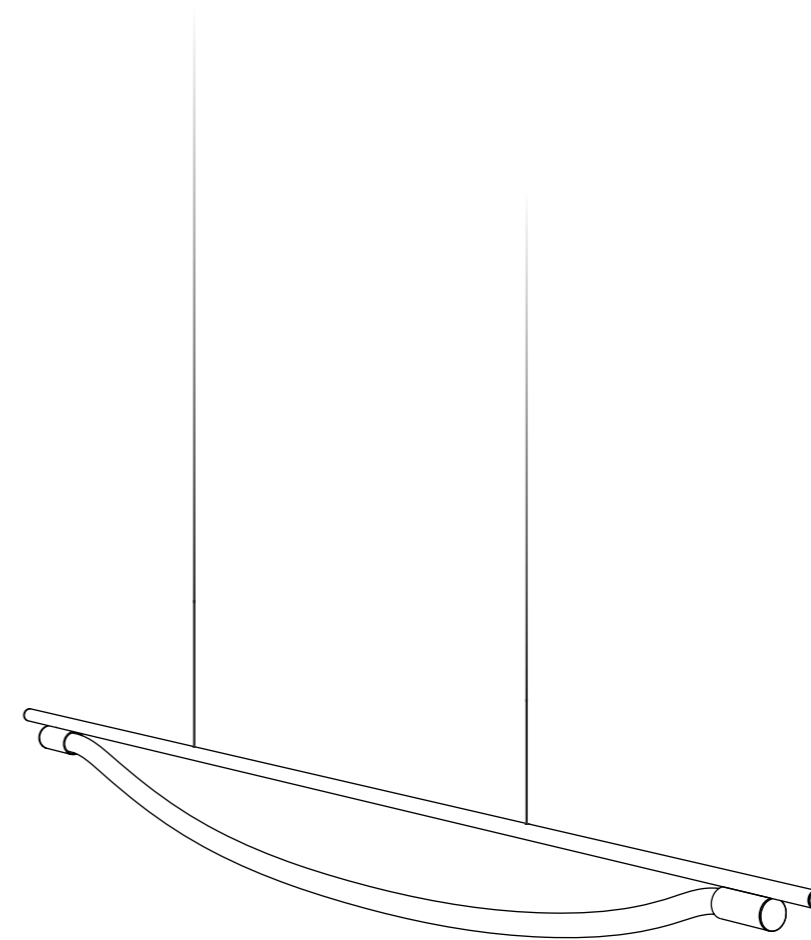

Linear



Levity Halo Pendant

Offered in two sizes, the Levity Halo Pendant creates two different visual experiences - the smaller delivering a traditional circle shape, the larger allowing for a more dramatic draping. Resting across a metal frame, the circular light radiates through a braided nylon textile sleeve, giving a sense of softness and elegance. A LED source is enclosed within a flexible silicone tube, providing even diffusion that conceals the integrated LED light source. Levity is easy to imagine adding artistic ambiance over a dining table in a residence, or making a visual statement in an office lobby.

Colors

Black

Dimensions

Halo180

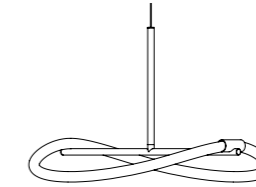

Ø 23.75, H 15 (in)
Ø 60, H 36 (cm)

Halo215

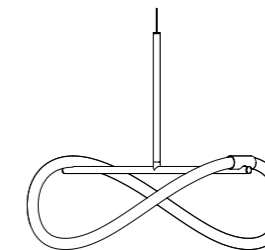

Ø 23.75, H 18 (in)
Ø 60, H 60 (cm)

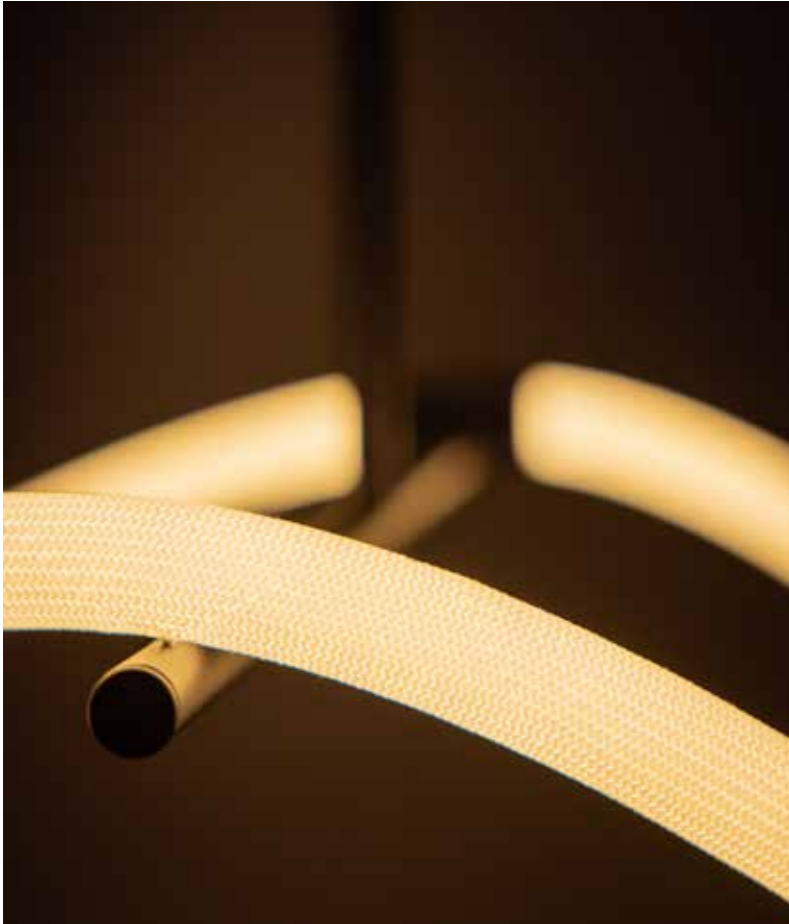

Levity Bow Linear

A variation on the Levity Halo pendant, the Levity Bow Linear fixtures or pendants are a commitment to effortless elegance; the powder coated metal frame holds up the soft, draped light in a simple, elegant statement. A LED source is enclosed within a flexible silicone tube and wrapped in a nylon textile sleeve, providing even diffusion that conceals the integrated LED light source. Offered in two lengths - the fixtures can be layered together or used as a singular lit element.

Colors

Black

Dimensions

Bow120



L 47.25, W 4.5, H 1.25 (in)
L 120, W 12, H 3 (cm)

Bow160

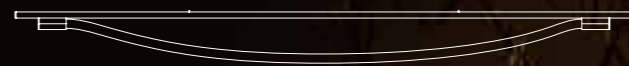

L 63, W 4.5, H 1.25 (in)
L 160, W 16, H 3 (cm)





Scrap

lights



Scrap

Scraplights are a sustainable fixture with a versatile aesthetic that elevates both residential and commercial spaces alike. Our series includes table lights, pendants, sconces and a linear fixture.

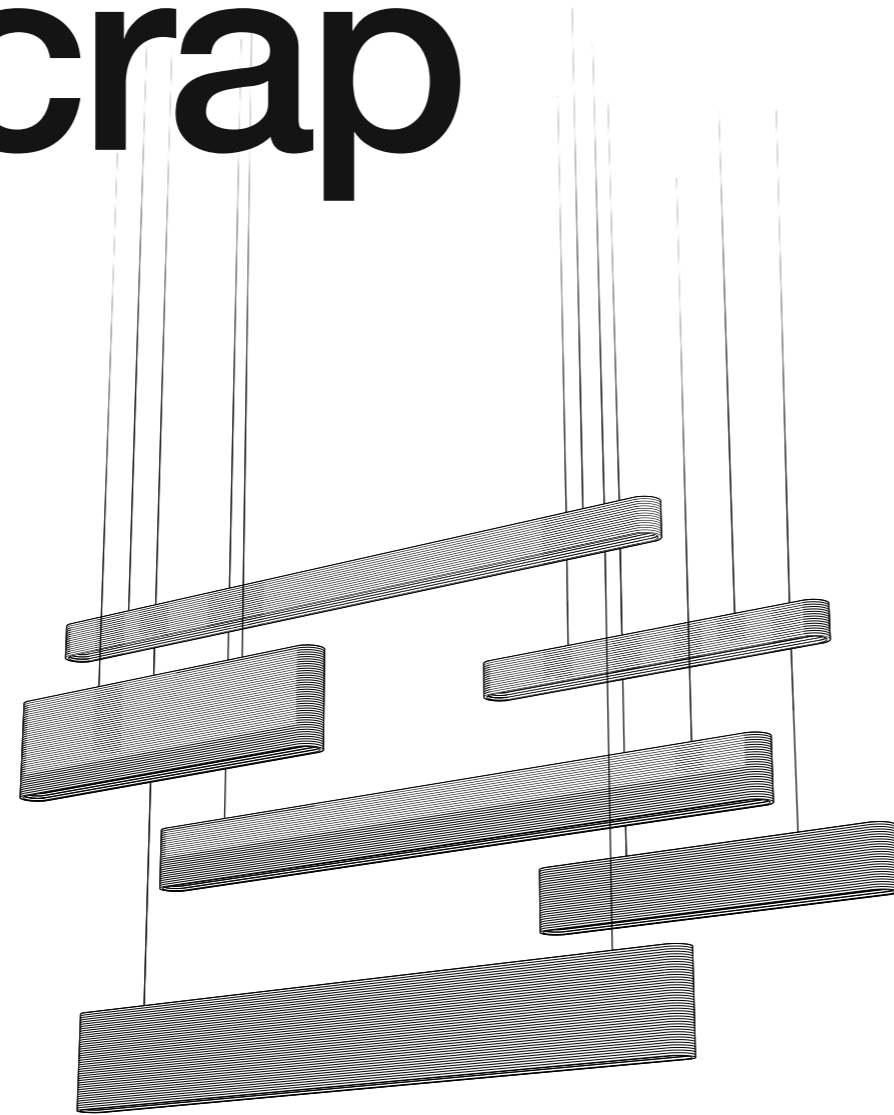

Linear Series

lights



Classic Series



Frame Series

It all started with Scraplights – sourcing post-consumer recycled cardboard and turning it into warm, diffused light. Scraplights have become our signature series, one we continue to love and evolve.

Scrap

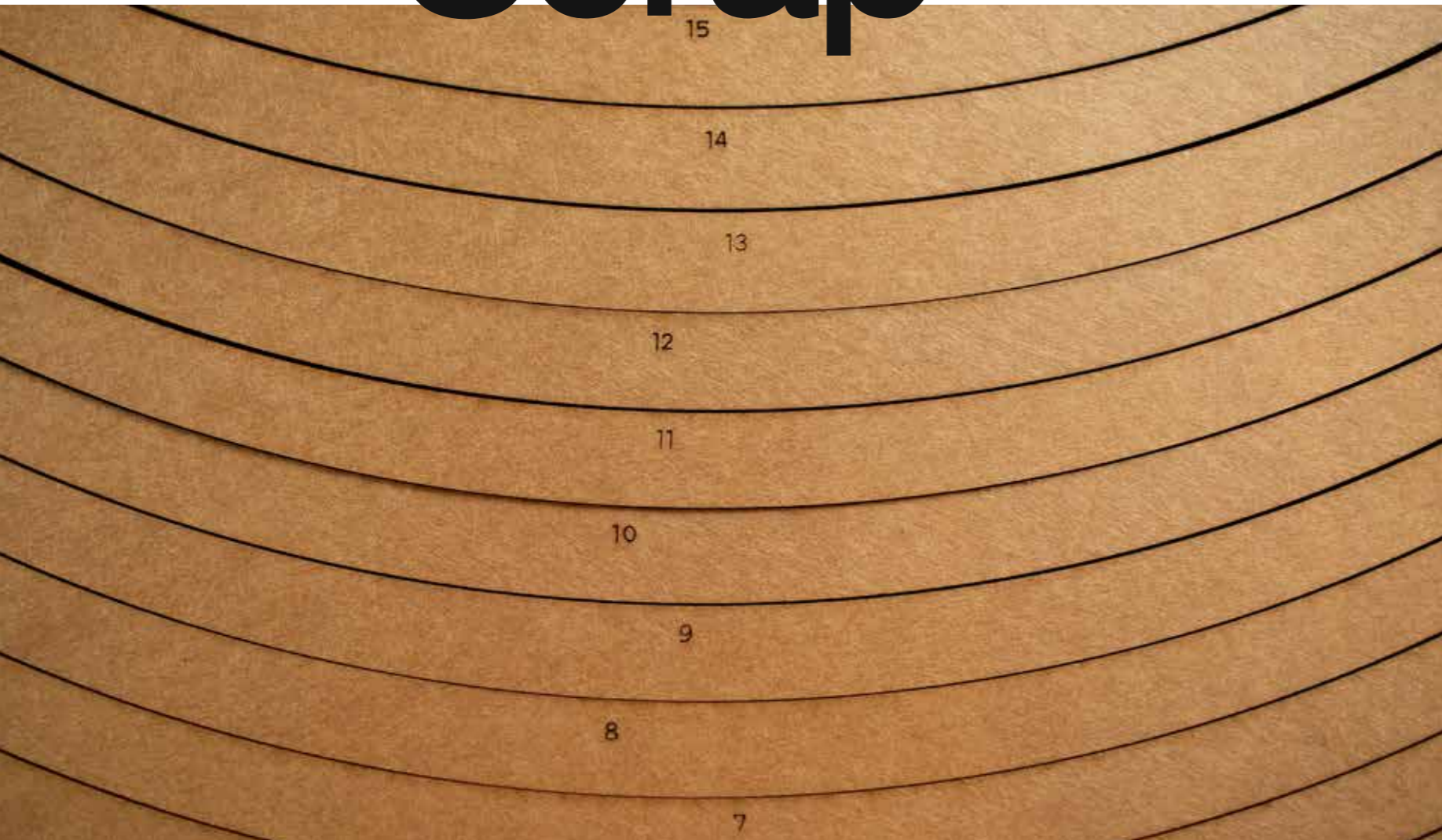

Graypants invests in innovative ideas that help create meaningful jobs. We believe our products have stories that transcend their designs. The stories are about the process and the people who take great pride in the quality of their work that goes into crafting and assembling each and every one of our light fixtures.

lights



Graypants started with Scraplights and the entire range is still handmade in our Seattle studio. We have since expanded into Europe, with an office in Amsterdam, and a team of makers in partnership with a social works program to provide craft-based work for those who need it most. Using local production gives Graypants the opportunity to provide meaningful work for communities - a great example of the brand's belief in responsible design, responsible materials and responsible production. Design in the end is really about people. Our products are an extension of the people, the faces and the stories behind them.

Depending on the finish, each piece of a Scraplights fixture is precision-cut with a laser or knife - Natural and Blonde welcome the subtle patina of the edge burn from the laser, while the White finish requires the use of a knife to achieve the pristine, white edges. Scraplights are then assembled by hand using non-toxic adhesive and treated with a non-toxic fire retardant. Tough and elegant, Scraplights provide warm, intimate, and functional lighting.

Scrap

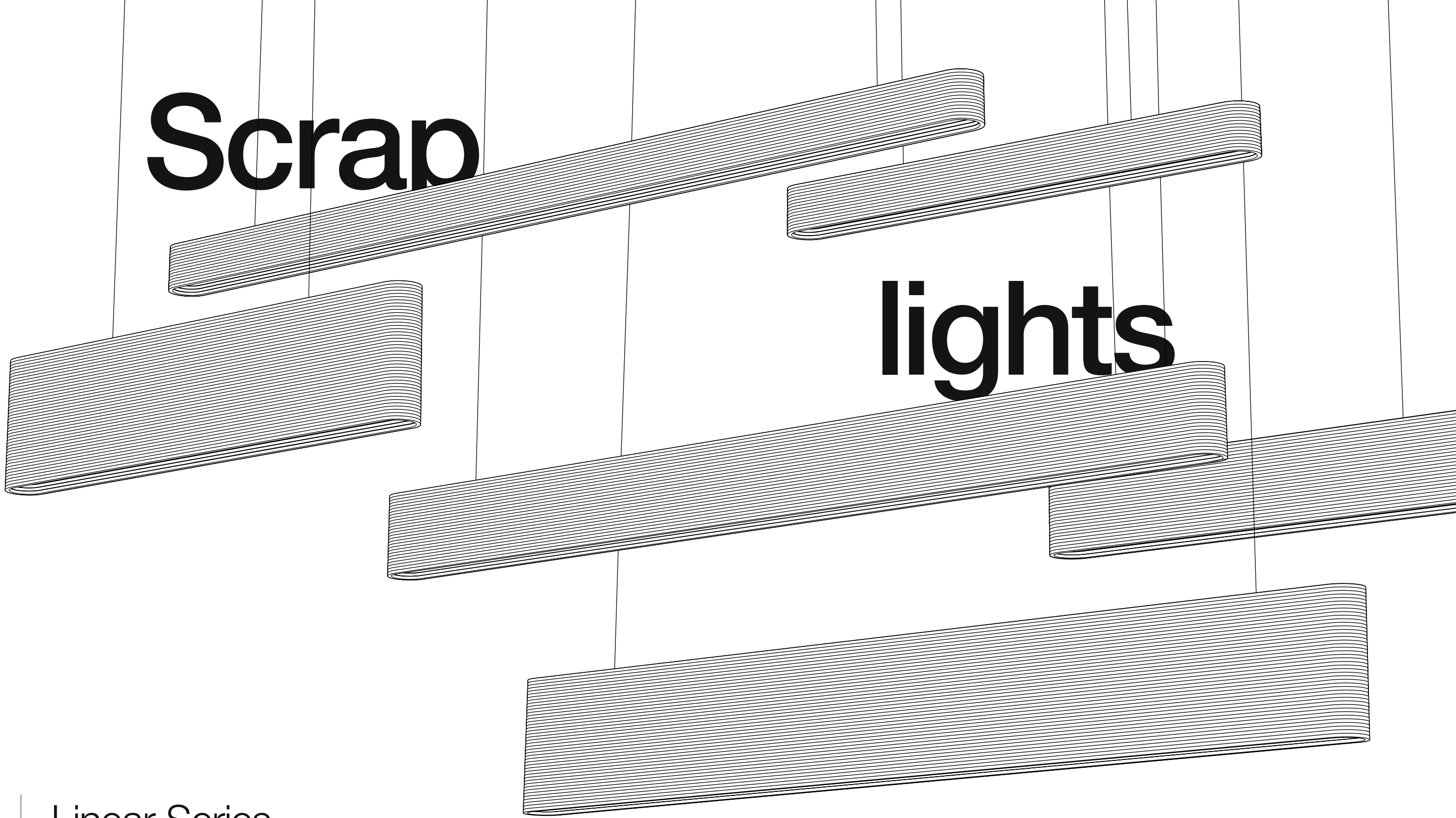

lights

Linear Series

Graypants continues to push and evolve expressions of our iconic Scraplights. Introducing Hewn, a linear shape that is as beautiful as it is hardworking. As a task light, Hewn will deliver more illumination than some of our other Scraplights expressions and the shape is very suitable over a desk, dining table or kitchen island. Hewn is handmade in Graypants' Seattle studio as well as in Amsterdam, and currently available globally.

Scraplights Hewn Linear

With Hewn linear, Graypants means to add a tactile and creative addition to a mundane field of task lighting, offering a beautiful light for all kinds of spaces. Hewn reflects a texture created using a new cutting process where layers of the shade are cut parallel to the flutes of the cardboard versus the perpendicular cut lines of our other shapes. This cutting process was intentional allowing us to build something beautiful and textural while also being fully opaque. Serving a wide range of brightness preferences, Hewn is dimmable and performs very well in both a home environment or commercial space. Hewn is available in three finishes—Natural, White and Blonde—and several lengths and heights.

Colors

- Natural
- Blonde
- White

Dimensions

Hewn48



L 47.5, W 4, H 4.25 (in)
L 121, W 10, H 11 (cm)

Hewn48

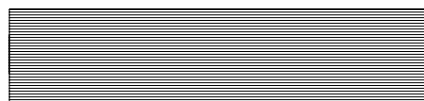

L 47.5, W 4, H 7.75 (in)
L 121, W 10, H 20 (cm)

Hewn48

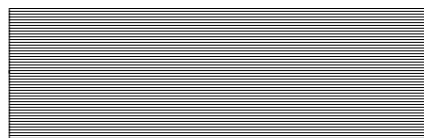

L 47.5, W 4, H 11.75 (in)
L 121, W 10, H 30 (cm)





Scrap

lights

Classic Series

Graypants continues to play and explore ways to apply cardboard in new and unique expressions. The classic series includes many of the best-selling silhouettes such as the Moon and Disc, along with newer designs like our most recent launch of the Madison within our Pebbles collection.



Scraplights Skew

Skew is the first Scraplights sconce and the perfect compliment to any Scraplights silhouette. Slim yet substantial, Skew gives a radiant glow that is perfect for illuminating a hallway in an office or hotel, or could just as easily rest above bedside tables.

Colors

- Natural
- Blonde
- White

Dimensions

Skew15

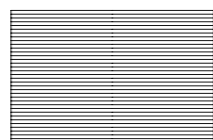

W 15, D 4, H 9.75 (in)
W 40, D 10, H 25 (cm)





Scraplights Moon

Colors	Natural
	Blonde
	White

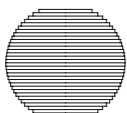
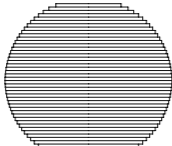
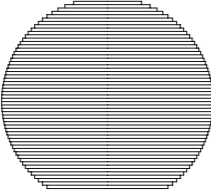
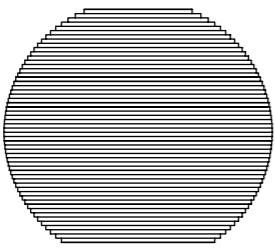
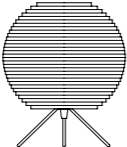
Dimensions	Moon10		Ø 10, H 9 (in) Ø 26, H 22 (cm)
	Moon14		Ø 14, H 12 (in) Ø 36, H 31 (cm)
	Moon18		Ø 18, H 16 (in) Ø 45, H 40 (cm)
	Moon24		Ø 24, H 21 (in) Ø 61, H 53 (cm)
	Moon10 Table Lamp		Ø 10, H 12 (in) Ø 25.5, H 30 (cm)







Scraplights Disc

Colors

Natural
Blonde
White

Dimensions

Disc16  Ø 17, H 7 (in)
Ø 43, H 19 (cm)

Disc20  Ø 20, H 9 (in)
Ø 50, H 23 (cm)

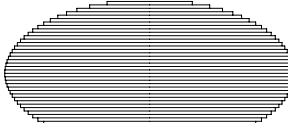
Disc24  Ø 24, H 10 (in)
Ø 61, H 26 (cm)





Scraplights Drop

Colors
Natural
Blonde
White

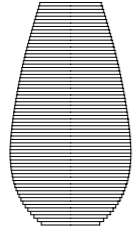
Dimensions
Drop18

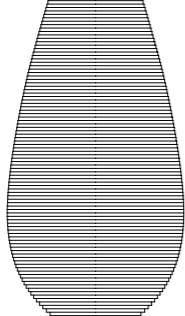
Ø 10, H 18 (in)
Ø 25, H 45 (cm)

Drop26

Ø 14, H 26 (in)
Ø 36, H 65 (cm)







Scraplights Bell

Colors

Natural
Blonde
White

Dimensions

Bell10

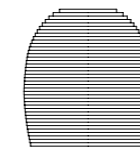

Ø 11, H 11 (in)
Ø 27, H 28 (cm)

Bell16

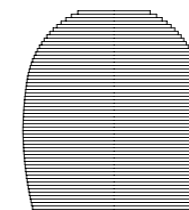

Ø 15, H 16 (in)
Ø 38, H 40 (cm)

Scraplights Ausi

Colors

- Natural
- Blonde
- White

Dimensions

Ausi8



Ø 7.75, H 9.5 (in)
Ø 20, H 24 (cm)

Ausi12



Ø 11, H 8.5 (in)
Ø 28, H 21 (cm)

Ausi14

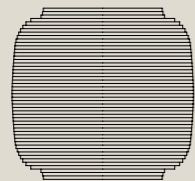

Ø 14.75, H 14 (in)
Ø 38, H 36 (cm)

**Ausi8
Table Lamp**



Ø 7.75, H 12.25 (in)
Ø 20, H 31 (cm)





62

63



Scraplights Pebbles

The latest addition to the Scraplights collection takes forms from pebbles gathered from various beaches near Graypants' Seattle studio. Each pebble shade is inscribed with the beach name and coordinates of the original stone that inspired it.

Colors

- Natural
- Blonde
- White

Dimensions

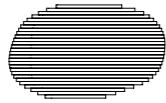
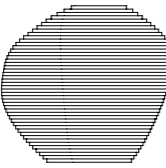
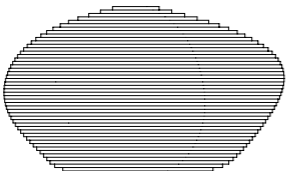
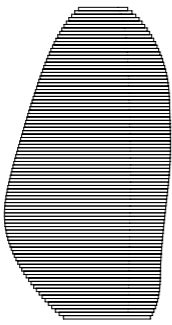
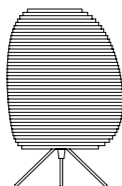
Alki		<p>Ø 12.5, H 7.5 (in) Ø 32, H 19 (cm)</p>
Allyn		<p>Ø 14, H 13.25 (in) Ø 36, H 33 (cm)</p>
Madison		<p>Ø 23.5, H 13 (in) Ø 60, H 33 (cm)</p>
Denny		<p>Ø 13.5, H 25.5 (in) Ø 34, H 65 (cm)</p>
Ebey		<p>Ø 10, H 16 (in) Ø 25, H 40 (cm)</p>

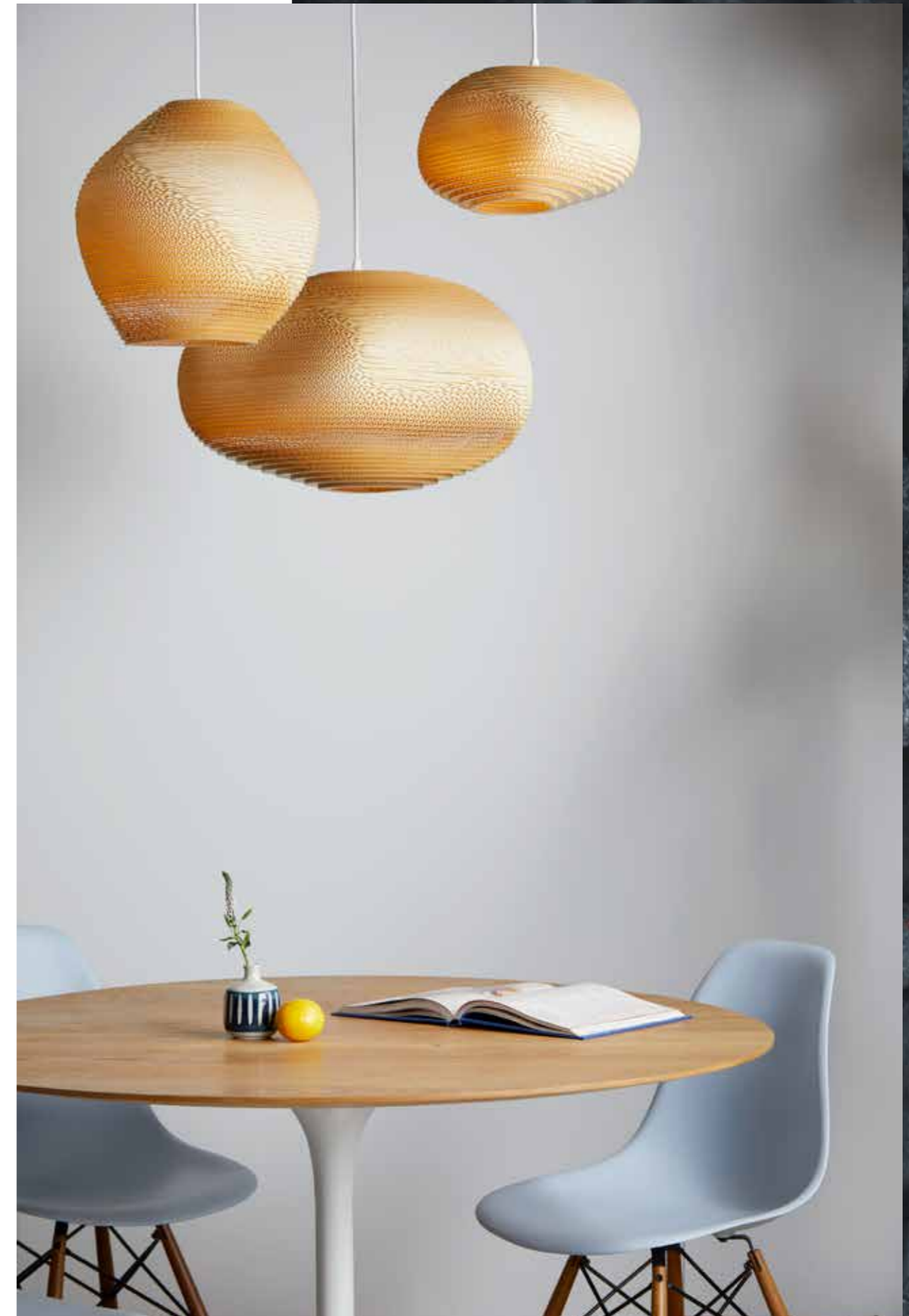

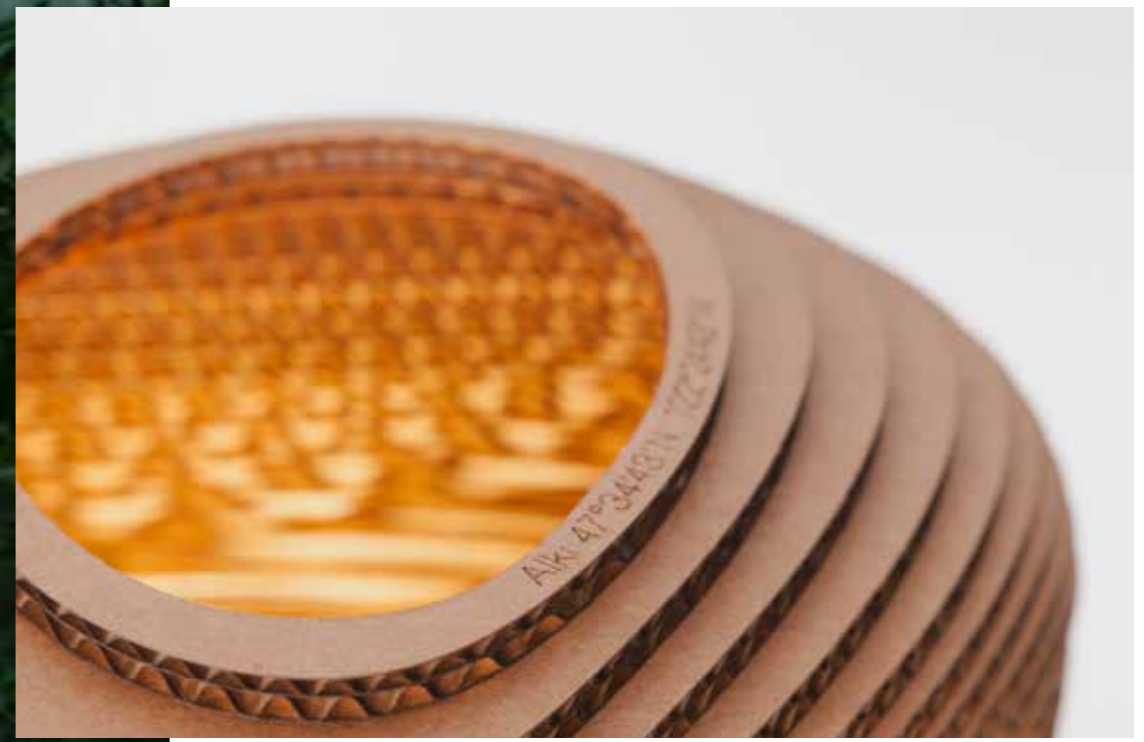





Scraplights Hive

Colors

Natural
Blonde
White

Dimensions

Hive9

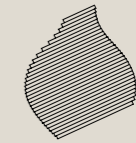

Ø 9, H 11 (in)
Ø 23, H 28 (cm)

Hive12

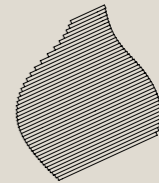

Ø 12, H 14.25 (in)
Ø 30, H 36 (cm)

Hive15

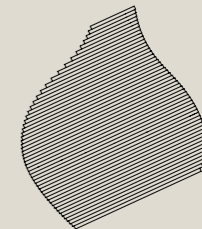

Ø 15, H 18.25 (in)
Ø 38, H 46 (cm)

& Nest

Colors

Natural
Blonde
White

Dimensions

Nest24

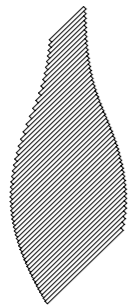

Ø 9.25, H 24.25 (in)
Ø 24, H 62 (cm)

Nest32

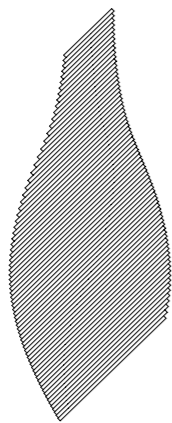

Ø 13.25, H 33.5 (in)
Ø 34, H 85 (cm)







Scrap

lights

Frame Series

The Frame Series represents our largest manifestations of Scraplights. Frame pendants combine the classic layered cardboard expression with a steel frame and a frosted glass diffuser. This creates a visually arresting decorative piece with excellent top and bottom lighting for large spaces such as lobbies and conference rooms.

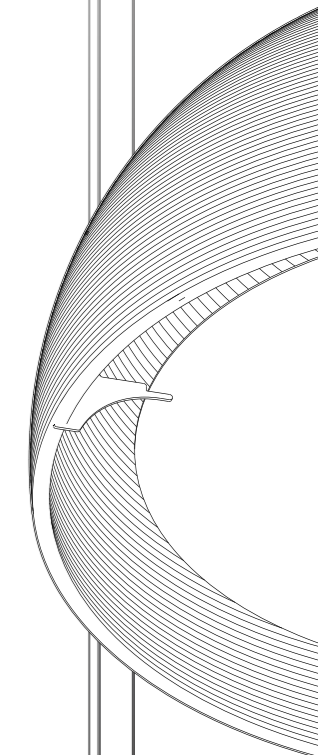
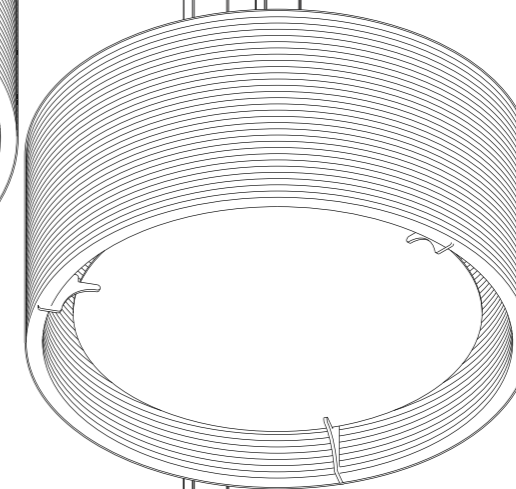
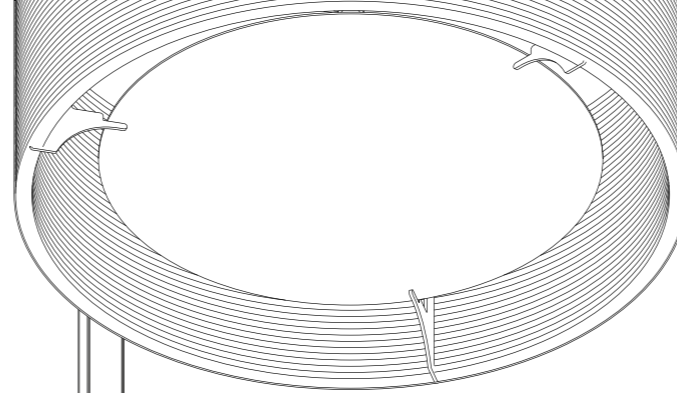
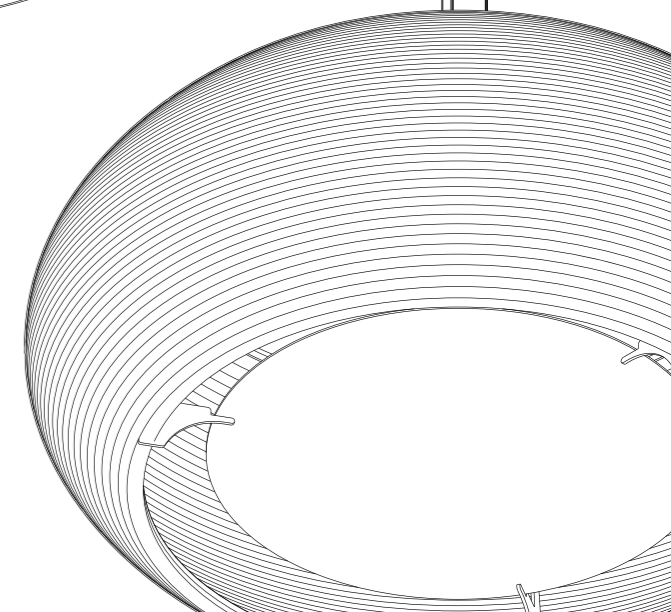
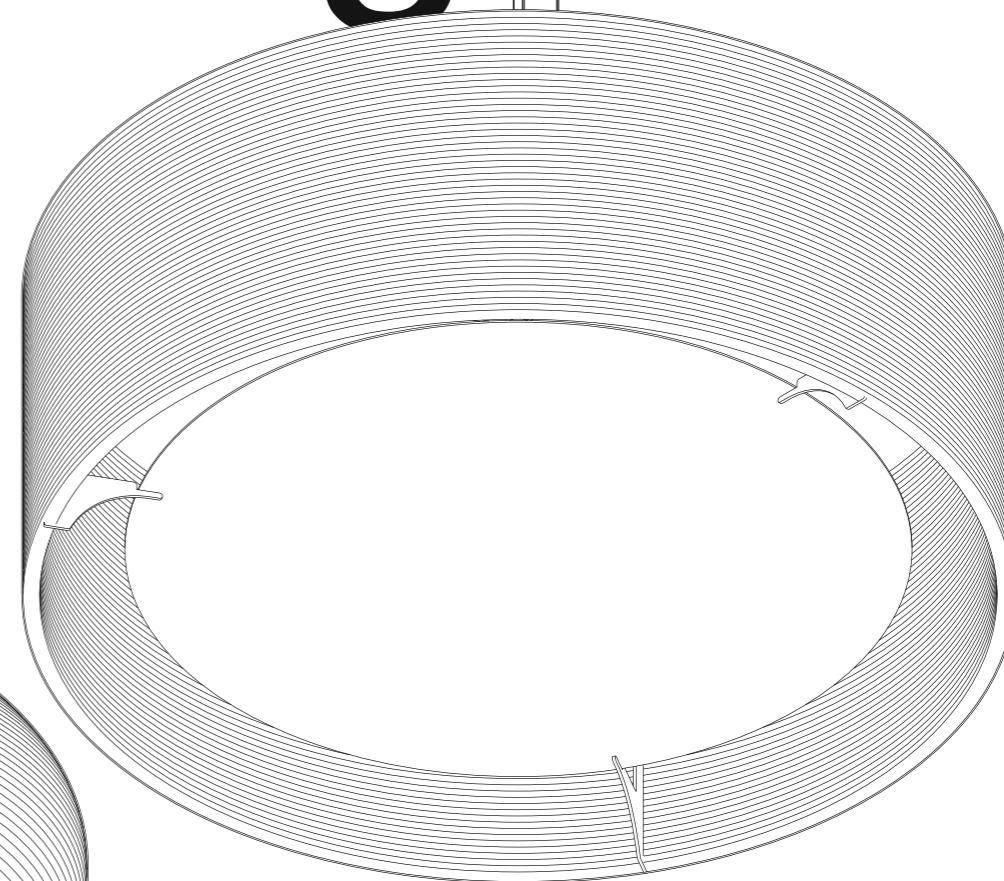
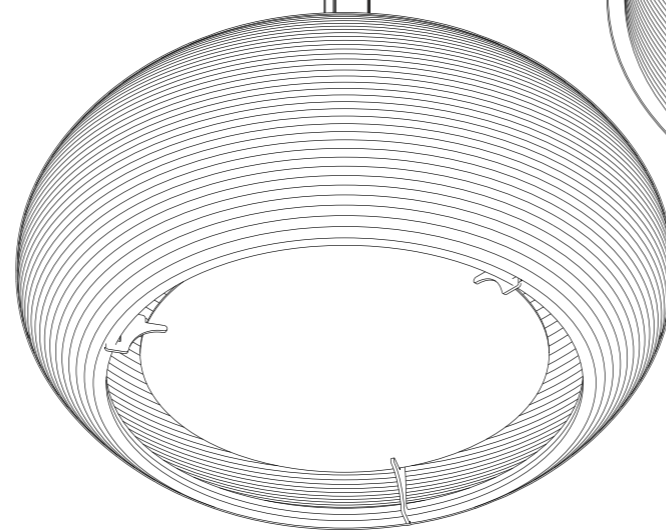
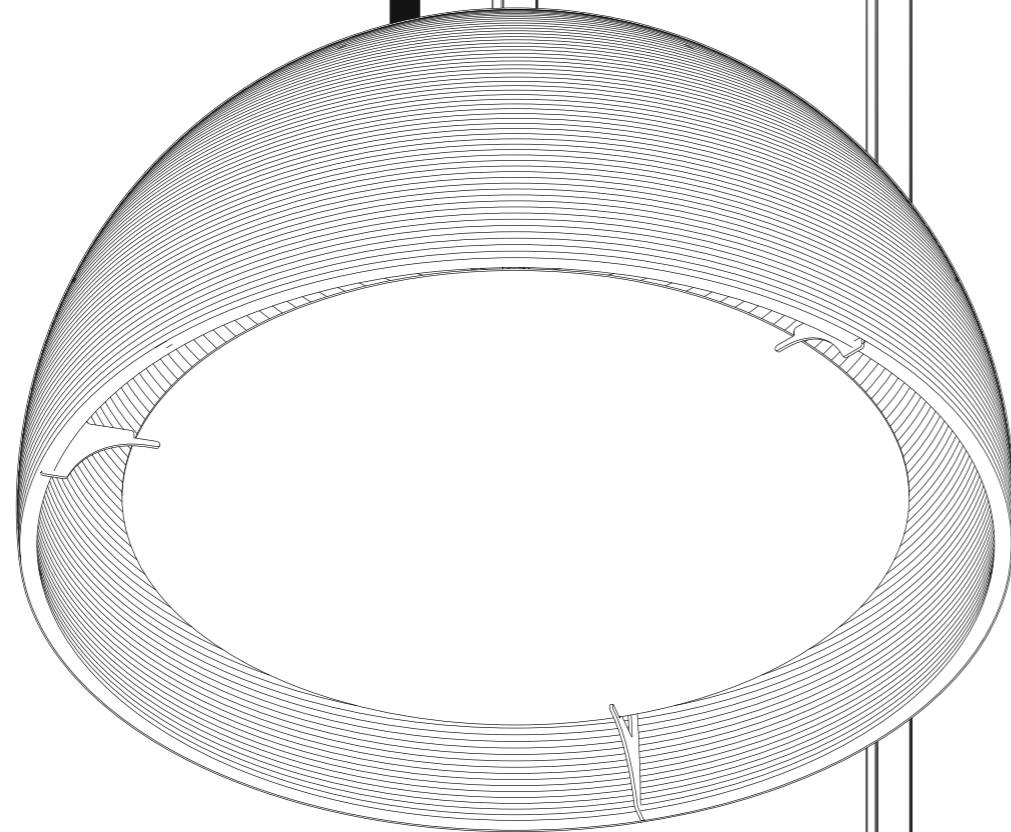



Scraplights Drum

Colors

Natural
White

Dimensions

Drum18

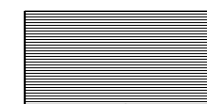

Ø 18, H 8.5 (in)
Ø 46, H 22 (cm)

Drum24

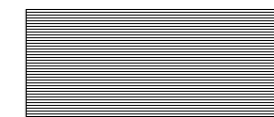

Ø 24, H 9.5 (in)
Ø 61, H 24 (cm)

Drum36



Ø 36, H 13.5 (in)
Ø 92, H 34 (cm)



Scraplights Ohio

Colors

- Natural
- White

Dimensions

Ohio24



Ø 24, H 10.25 (in)
Ø 61, H 26 (cm)

Ohio32

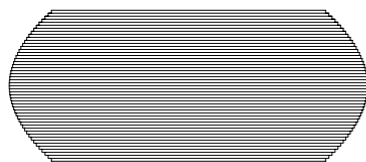

Ø 31.75, H 13.25 (in)
Ø 81, H 35 (cm)





Scraplights Dome

The Dome pendant combines half of the well-known Sun32 design with an even larger diffuser, making it ideal for spaces needing more functional lighting, such as an open office or event space.

Colors
Natural
White

Dimensions
Dome36

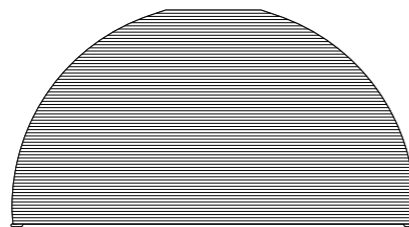

Ø 36.5, H 19.75 (in)
Ø 93, H 50 (cm)







Scraplights Sun

Colors
Natural
White

Dimensions

Sun32

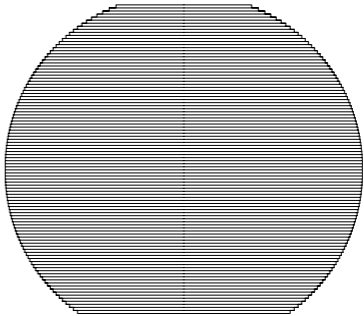

Ø 32, H 29.25 (in)
Ø 81, H 74 (cm)

Sun48

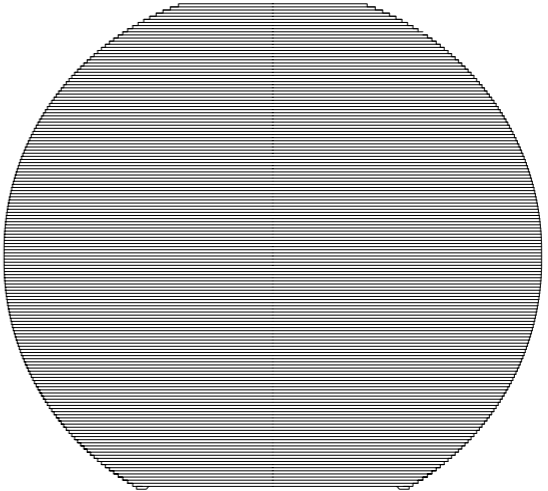

Ø 47, H 43 (in)
Ø 128, H 108 (cm)

& Arcturus

Colors

Natural
White

Dimensions

Arcturus

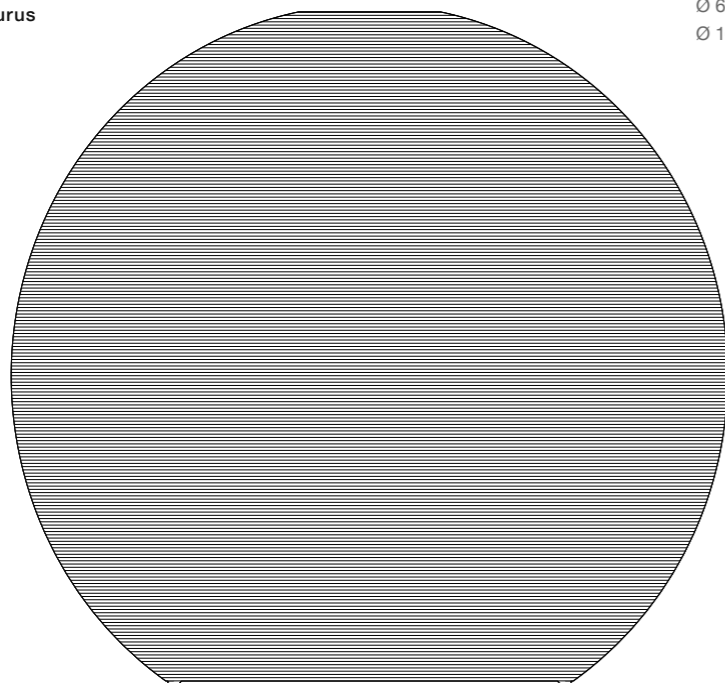

Ø 64, H 58 (in)
Ø 163, H 147 (cm)





Chro

na

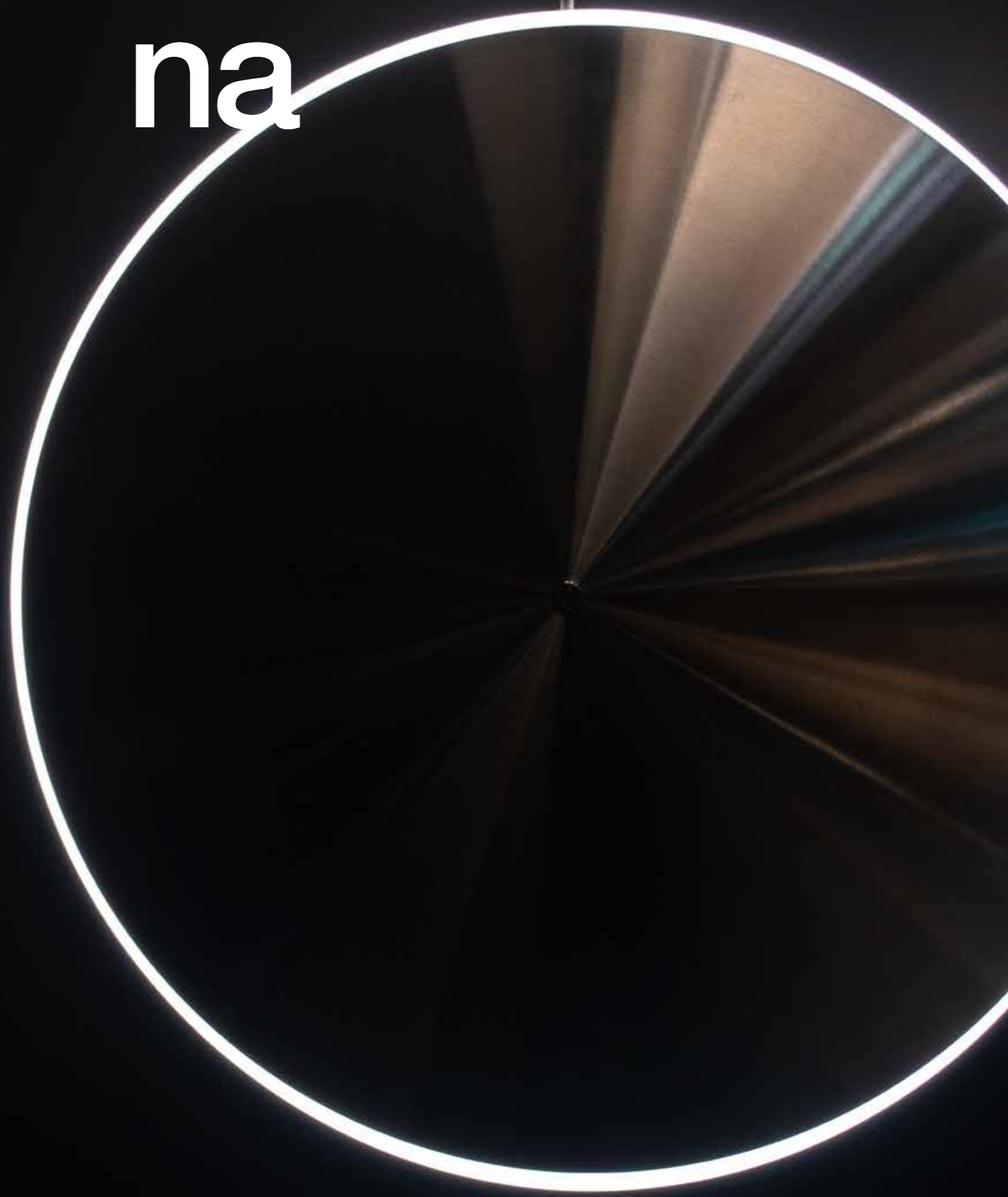

Chro

Chrona fixtures are warm, modern expressions, harnessing a charm that is both timeless and futuristic. Spun brass comes together sandwiching an acrylic diffuser that traces the silhouette of each fixture, providing even diffusion of the integrated LED light source. Chrona is available in both horizontally or vertically oriented pendants, and also as a sconce or table lamp. With a variety of sizes and configurations, Chrona can be clustered together to make constellations or stand out alone.

na

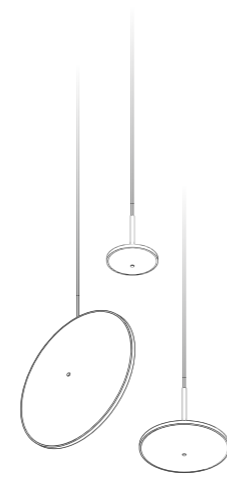

Dish Pendant

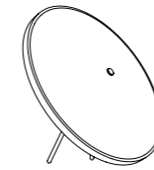
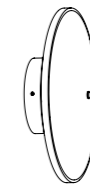

Table lamp



Sconce

Mimicking the phosphorescent envelope found around stars, Chrona creates a warm, atmospheric glow.

Chrona Pendant

Much like staring into the night sky, Chrona dish pendants hang freely, allowing the user to experience the natural refraction and twinkling of light coming from subtle movement and playing off the beautifully finished brass.

Slim and robust, the pendants are available in diameters ranging from 6 to 17 inches. Offered in both horizontal and vertical orientations, Chrona dish pendants can combine to create stunning constellation-inspired clusters, or can be individually hung to accentuate an area.

Colors

- Brass
- Stainless Steel

Dimensions

Dish6h



Ø 5.5, H 7 (in)
Ø 14, H 18 (cm)



Ø 5.5, D 2 (in)
Ø 14, D 5 (cm)

Dish10h



Ø 9.5, H 9.25 (in)
Ø 24, H 23 (cm)

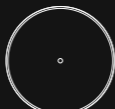

Ø 9.5, D 2.25 (in)
Ø 24, D 6 (cm)

Dish17h

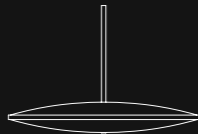

Ø 16.75, H 11.5 (in)
Ø 43, H 29 (cm)

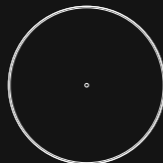

Ø 16.75, D 3" (in)
Ø 43, D 7 (cm)





Chrona Table Lamp

Colors

Brass

Dimensions

Table10

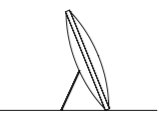

W 9.5, D 5.25, H 8.5 (in)
W 24, D 13, H 22 (cm)





Chrona Sconce

Taking direct inspiration from a solar eclipse, the Chrona wall sconce is a powerful expression giving off a subtle, warm glow.

The Chrona wall sconce can be affixed to the wall in mixed clusters, or used alone as a singular, modern element.

Colors

Brass

Dimensions

Sconce10



Ø 9.5, D 3 (in)
Ø 24, D 8 (cm)



Roest

/roōst/

Roest

/roōst/

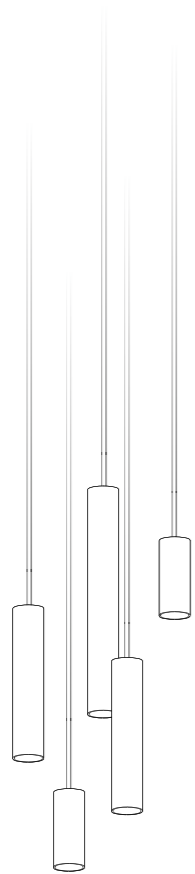

Pendant

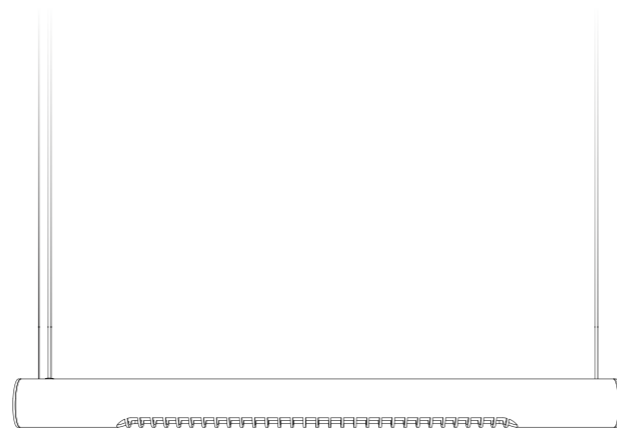

Linear

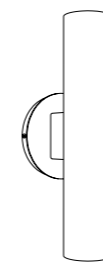

Sconce

For Roest, we partnered with Netherlands-based designer VanJoost. In his native language, roest means rust, and this highly textured series shows the natural relationship between the elements, time, oxygen, and iron. Roest Highlights Graypants unique fascination with nature and material research. Roest is made from naturally rusted and zinc-coated steel, and powered by a LED bulb. A minimal black cord connects to a black powder coated canopy. Bringing textures we usually experience in nature to the interior environment. Roest makes the industrial delicate, and lends warmth to a sleek modern form.

Roest is available as a pendant, sconce, and linear fixture, and adds focused light to office, home, and hospitality settings.

Bringing textures we usually experience in nature to the interior environment. Roest makes the industrial delicate, and lends warmth to a sleek modern form.

Roest

/roōst/

In their first outside collaboration, Graypants teamed up with Dutch designer VanJoost to expand on their curiosities and learn the craft of another designer. The collaboration with VanJoost highlights Graypants unique fascination with nature and material research.

Roest reflects unpretentious simplicity, and the unique finish on every single piece is what makes this collection truly special. To achieve the desired patina, each piece is finished by hand, and no two are alike. VanJoost starts with raw, steel pipes and rinses them in a vinegar bath which seeps into the pores of the metal creating a hardy and pitted surface - this helps the subsequent rusting process set in, in a deeper way. Each piece is then treated with a solution that starts a chemical reaction accelerating the effects of how elements would impact steel over time - a process that would otherwise take more than six months. Designed by VanJoost and hand-made in Holland, Roest presents natural colors that elevate any setting.





Roest Pendant

Colors

- Rust
- Rust + Zinc
- Zinc
- Carbon

Dimensions

15v Pendant



Ø 2.375, H 6 (in)
W

30v Pendant



Ø 2.375, H 11.75 (in)
Ø 6, H 30 (cm)

45v Pendant



Ø 2.375, H 17.75 (in)
Ø 6, H 45 (cm)

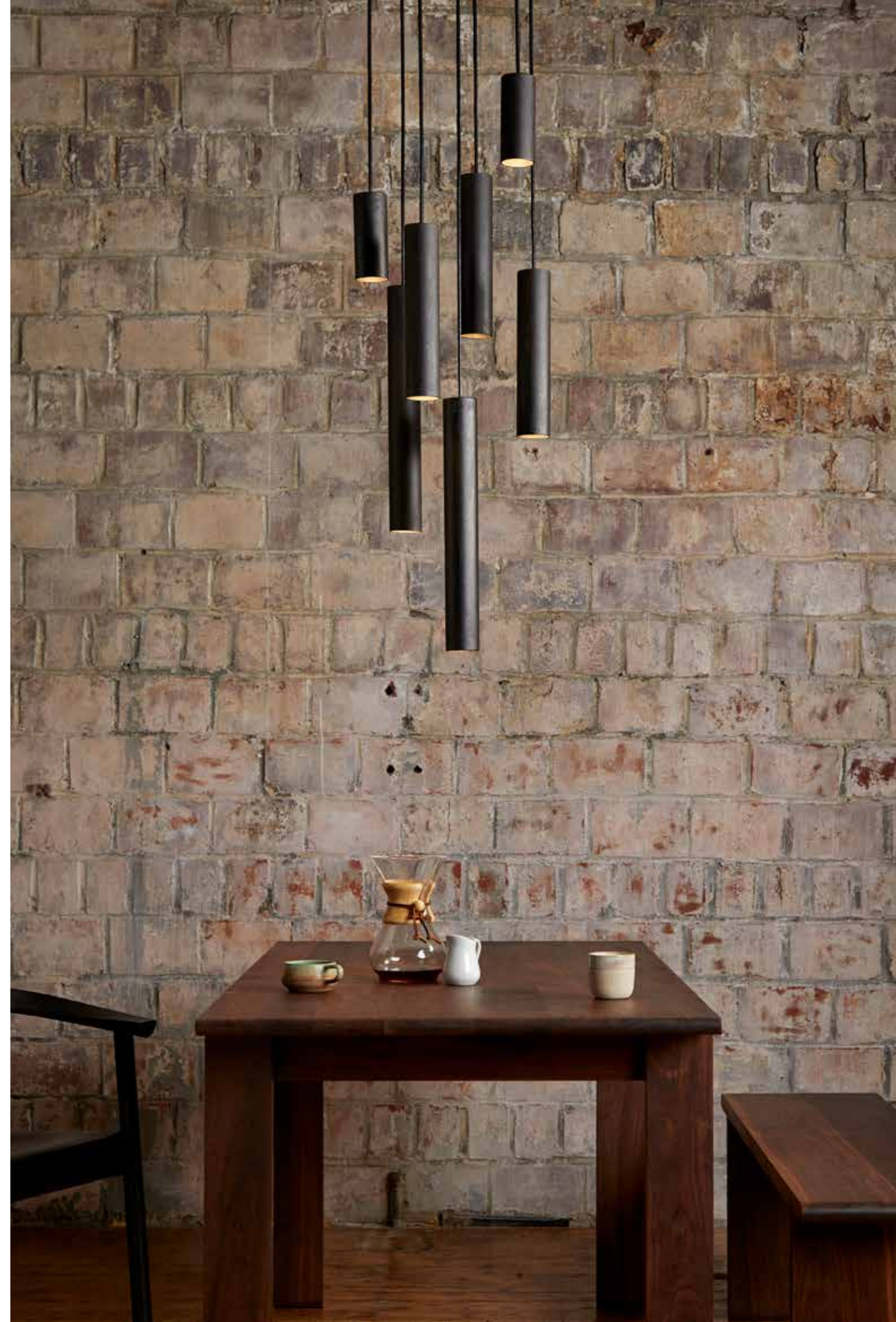

Roest Linear

Colors

- Rust
- Zinc
- Carbon

Dimensions

75h Pendant

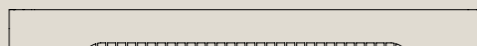

Ø 2.375, L 29.5 (in)
Ø 6, W 75 (cm)

150h Pendant

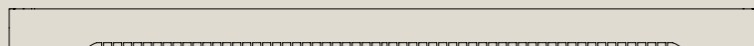

Ø 2.375, L 59 (in)
Ø 6, W 150 (cm)



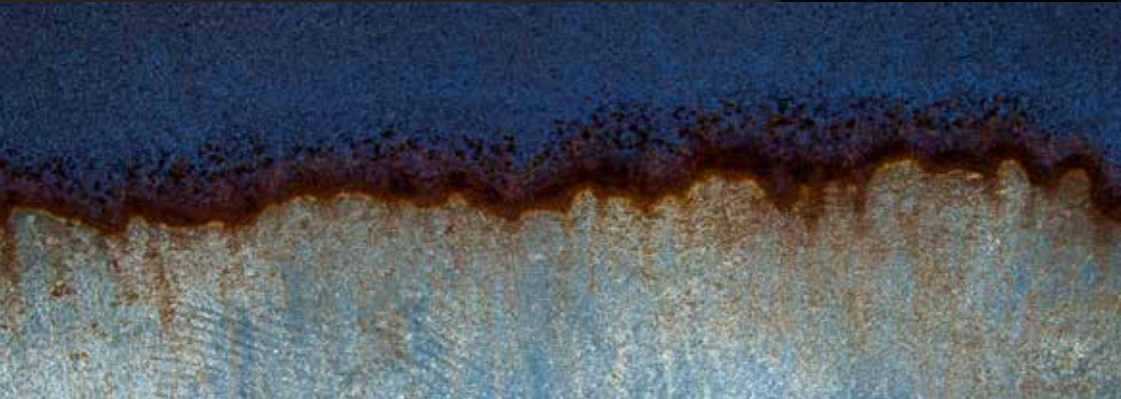



Roest Sconce

Colors

- Rust
- Zinc
- Carbon

Dimensions

Sconce30

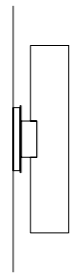

Ø 2.375, H 11.75 (in)
Ø 6, H 30 (cm)





Roest Ceiling

Colors

Rust

Dimensions

Ceiling10

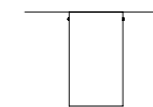

Ø 4.5, H 8 (in)
Ø 11.4, H 20 (cm)

Murmurations



Murmurations

Murmurations are custom installations inspired by the breathtaking natural phenomenon of Flocking and the incredible sight of thousands of starlings flying together in unison. Flocking is considered an emergent behavior arising from simple rules that are followed by individuals without any central coordination. By creating our own simple design rules, we are able to create dynamic light installations comprising of a single layered cardboard pendant. A Murmurations fixture is a versatile and spectacular LED chandelier with endless customization possibilities, from just a few to hundreds of pendants, installations can be customized to fit your specifications and make a grand impression in any space.

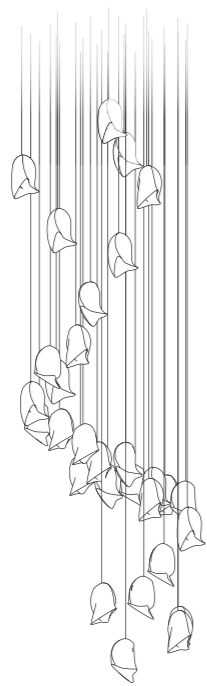

Tornado

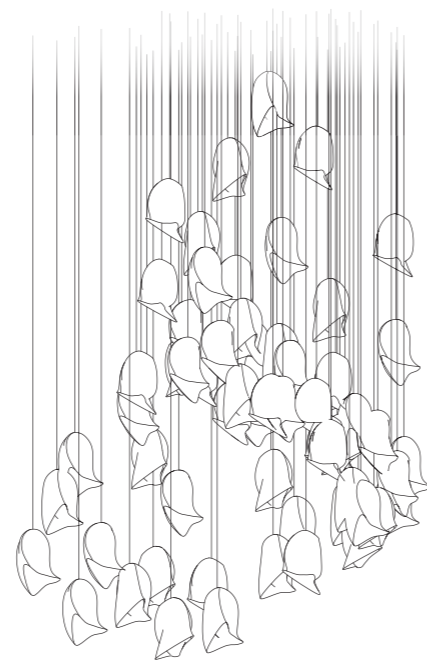

Flock Small

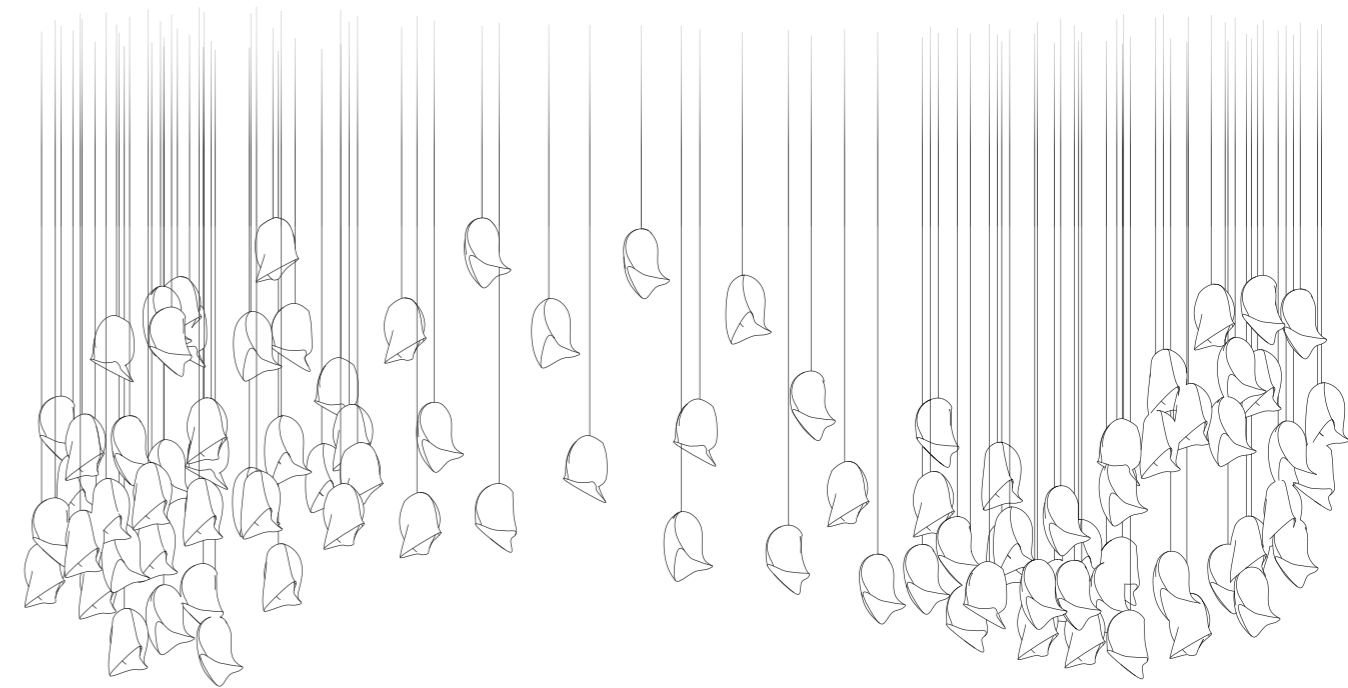

Flock Large

Murmurations are fixed shapes, but the relationship of each individual pendant within the group creates an experience of complex motion.



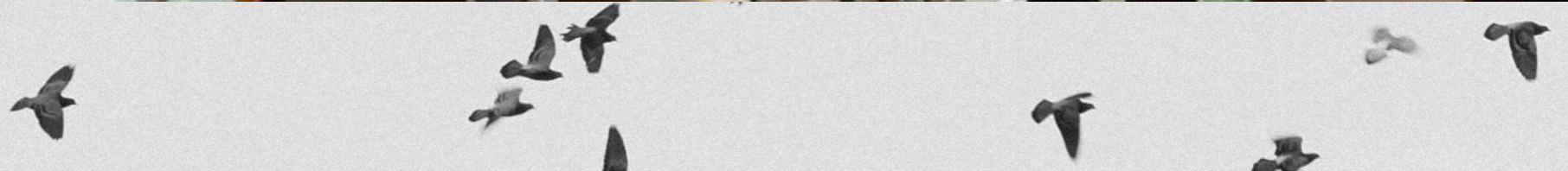



Loci

Loci

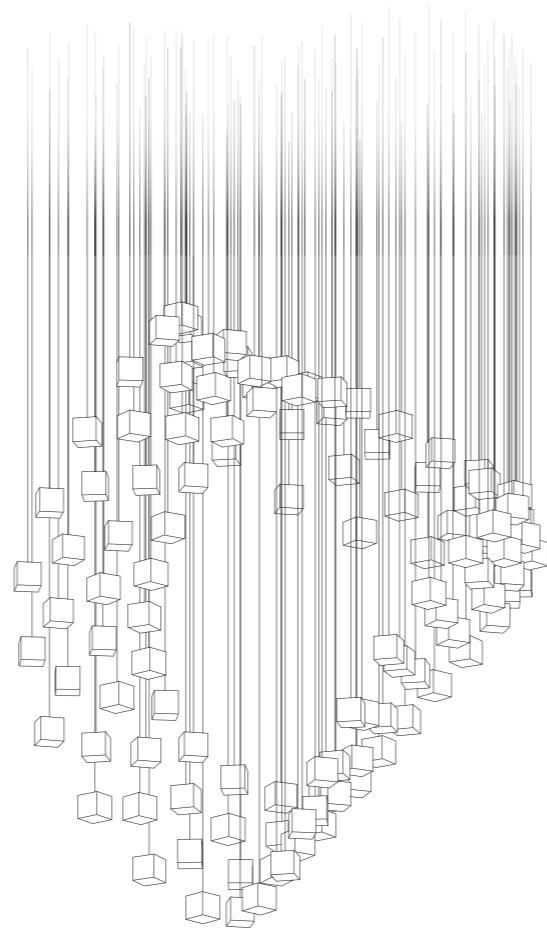

Loci is an innovative and highly customizable suspension light. The name, Latin in origin, translates to a particular position, point, or place, and refers to the series' innovative method of achieving hundreds or thousands of singular points of light in an installation.

Loci comes in five standard designs: Ring, Spiral Ring, Mobius, Rain and Wave, but any number of pendants can be used to create unique designs customized to fit your specifications. The individual pendants within each design are made of solid frosted diffusers and can also be specified in various shapes. When lit, the pendants emit a soft glow highlighting their respective designs in tandem with a powerful expression of the overall design of the installation.

Mobius

The Loci suspension light works especially well in large open spaces such as building lobbies and tall spaces such as stairwells, where the light can be customized to create spectacular installations.

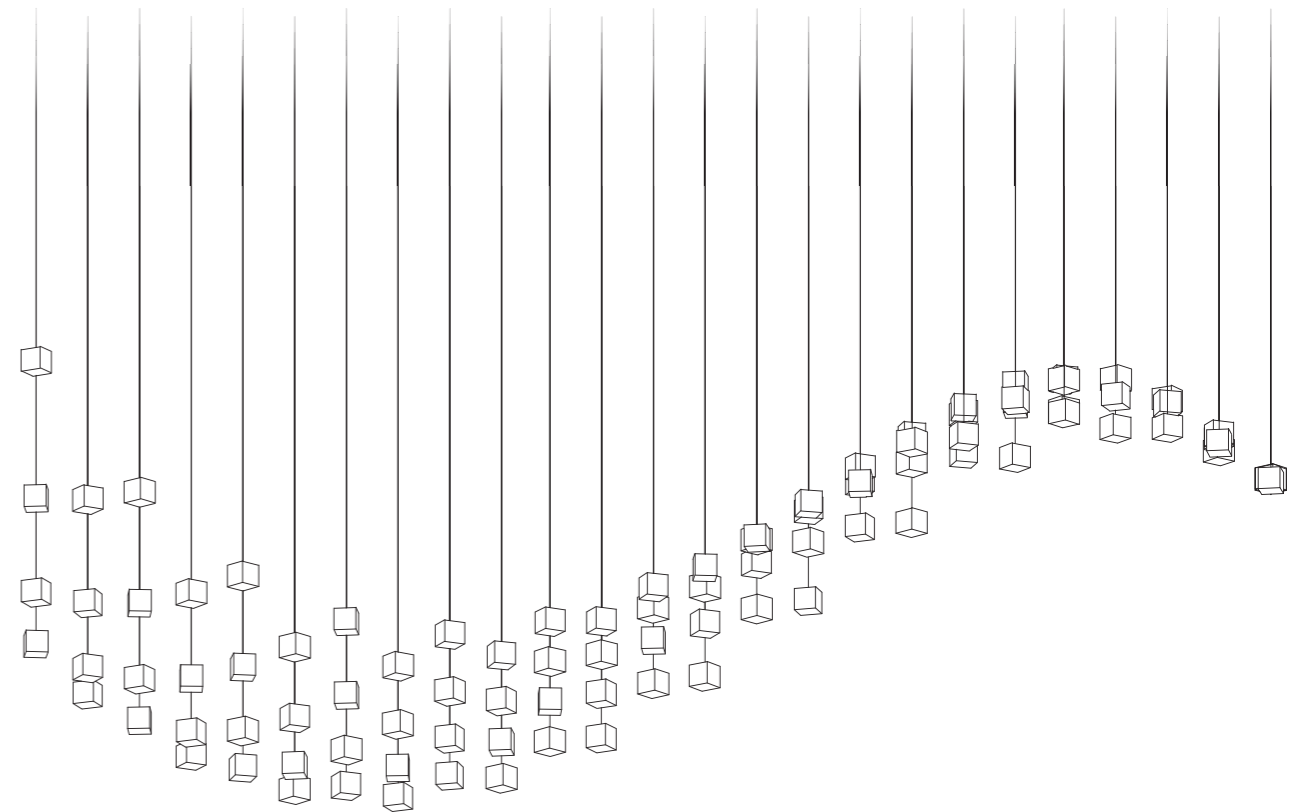

Wave

Loci

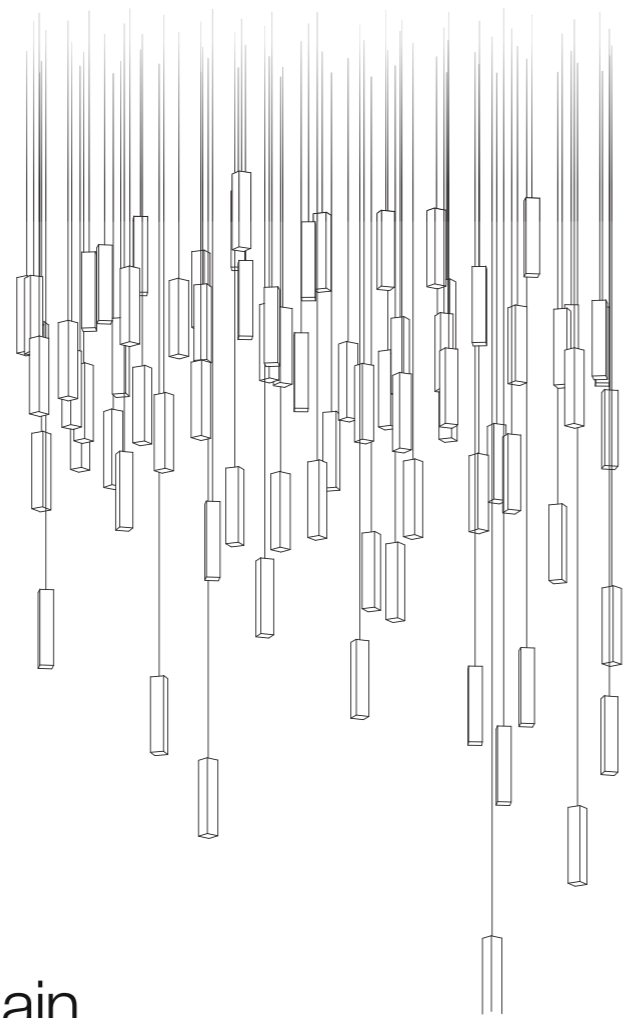
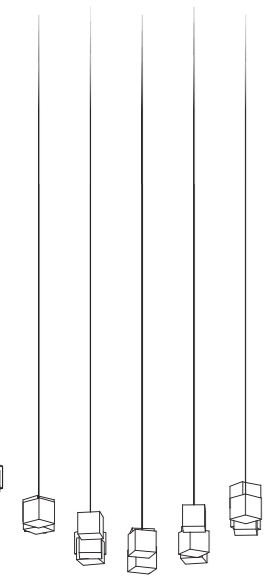

Rain

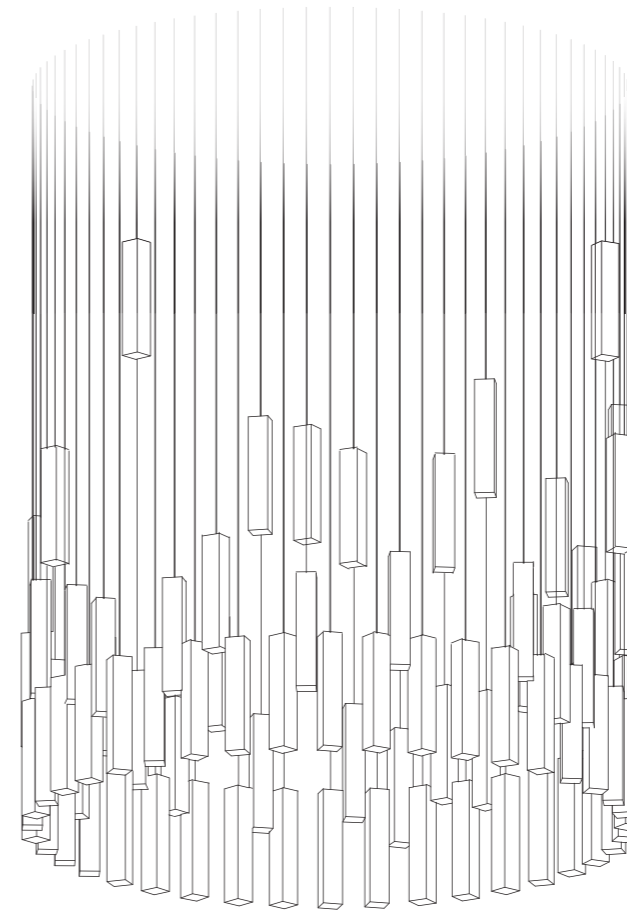

Ring

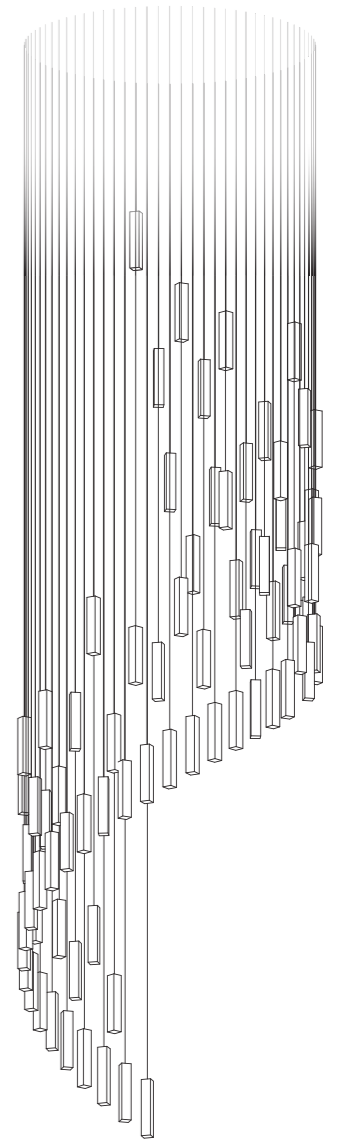

Spiral Ring





Custom Projects

Custom installations represent the intersection of imagination and specificity, allowing for something truly unique and awe-inspiring, that is also created with intention for the surrounding space and the users who will share the experience.

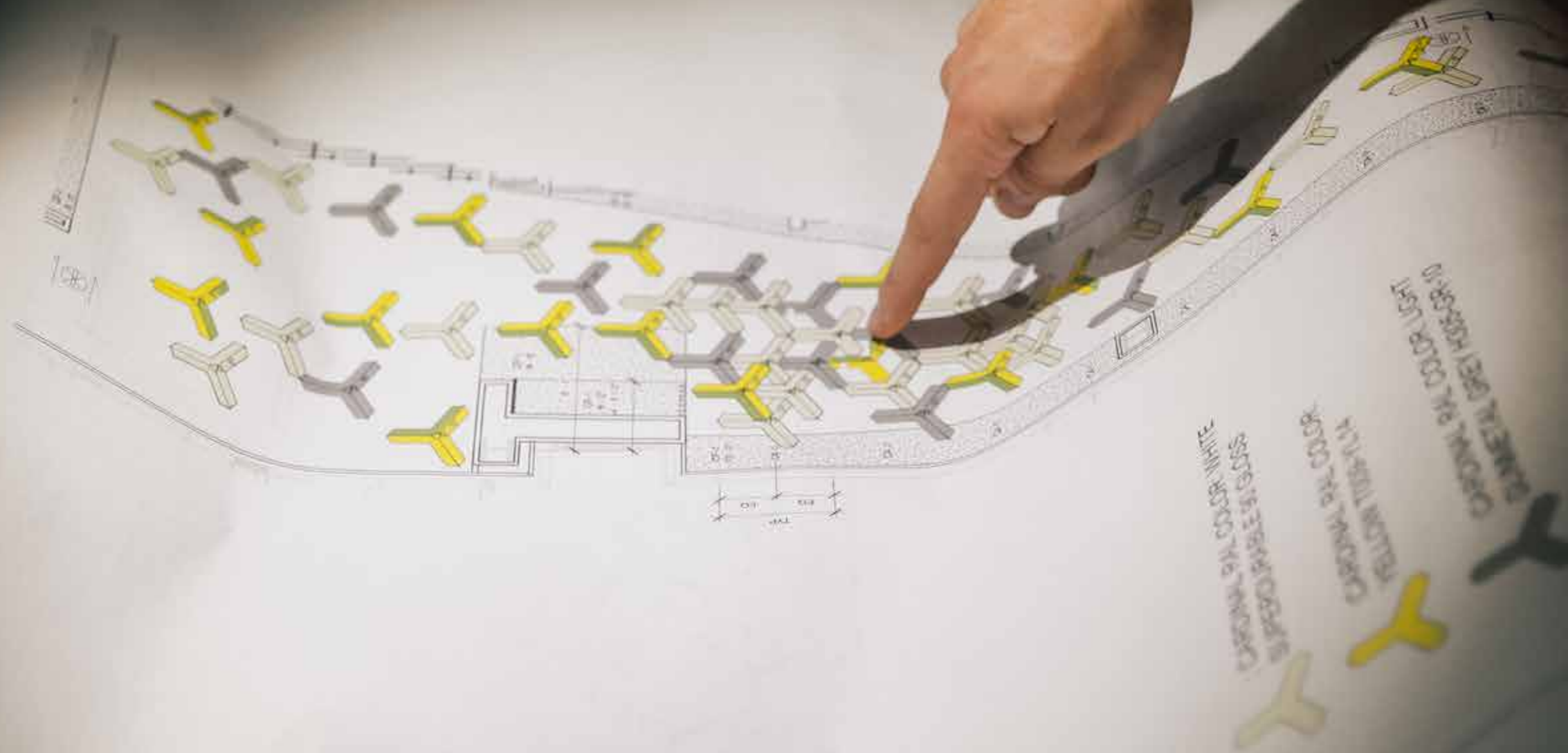





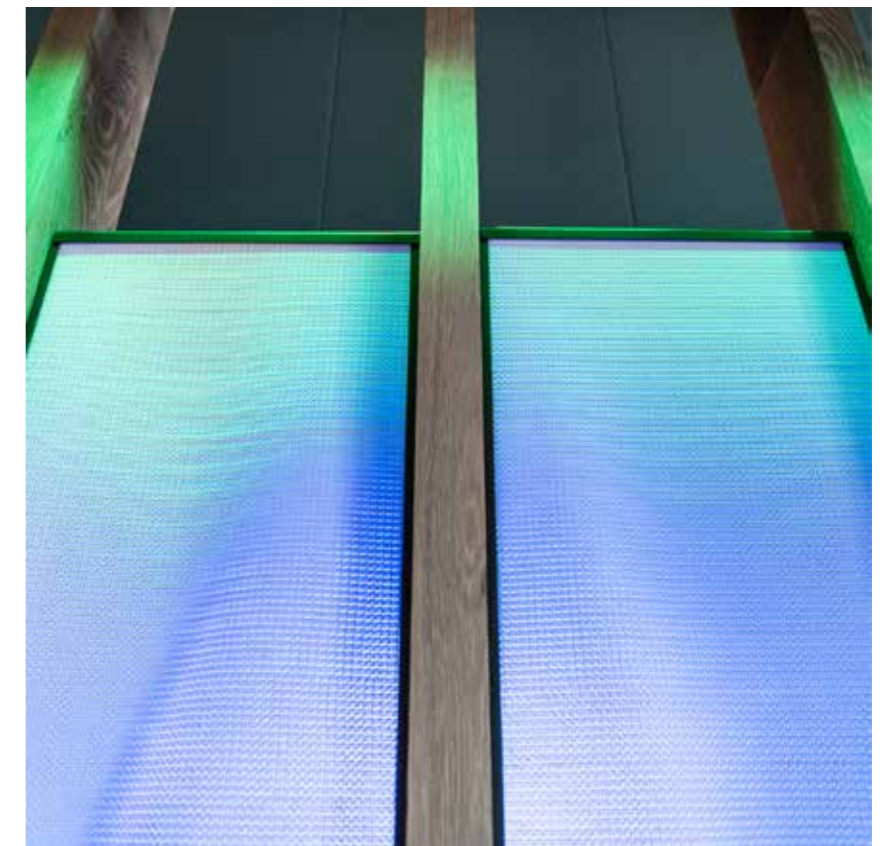

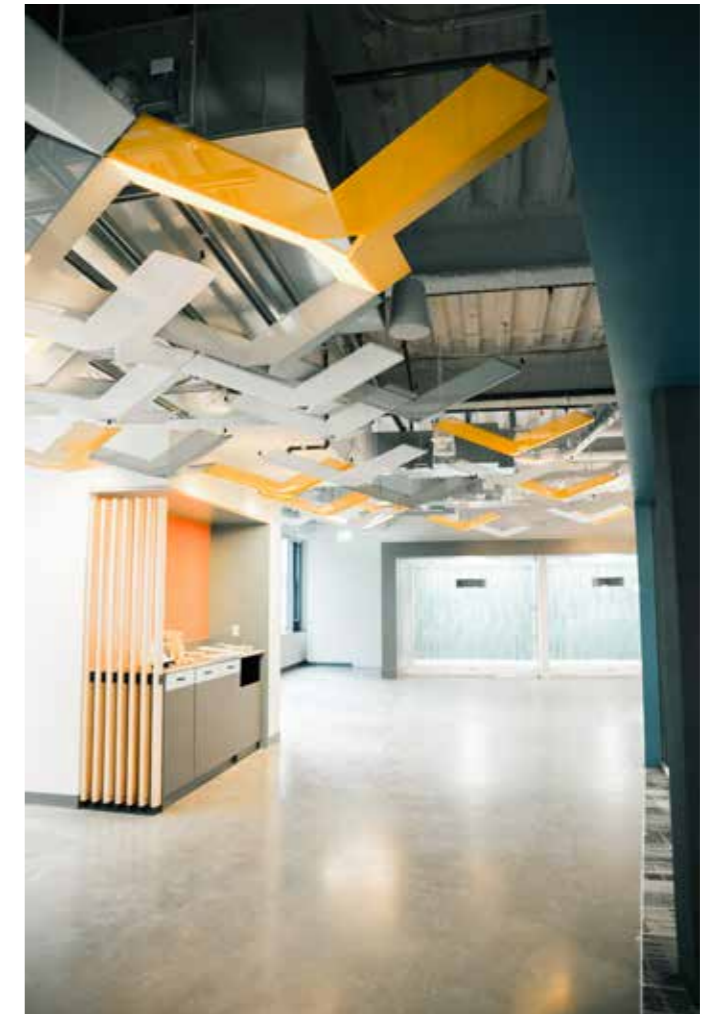
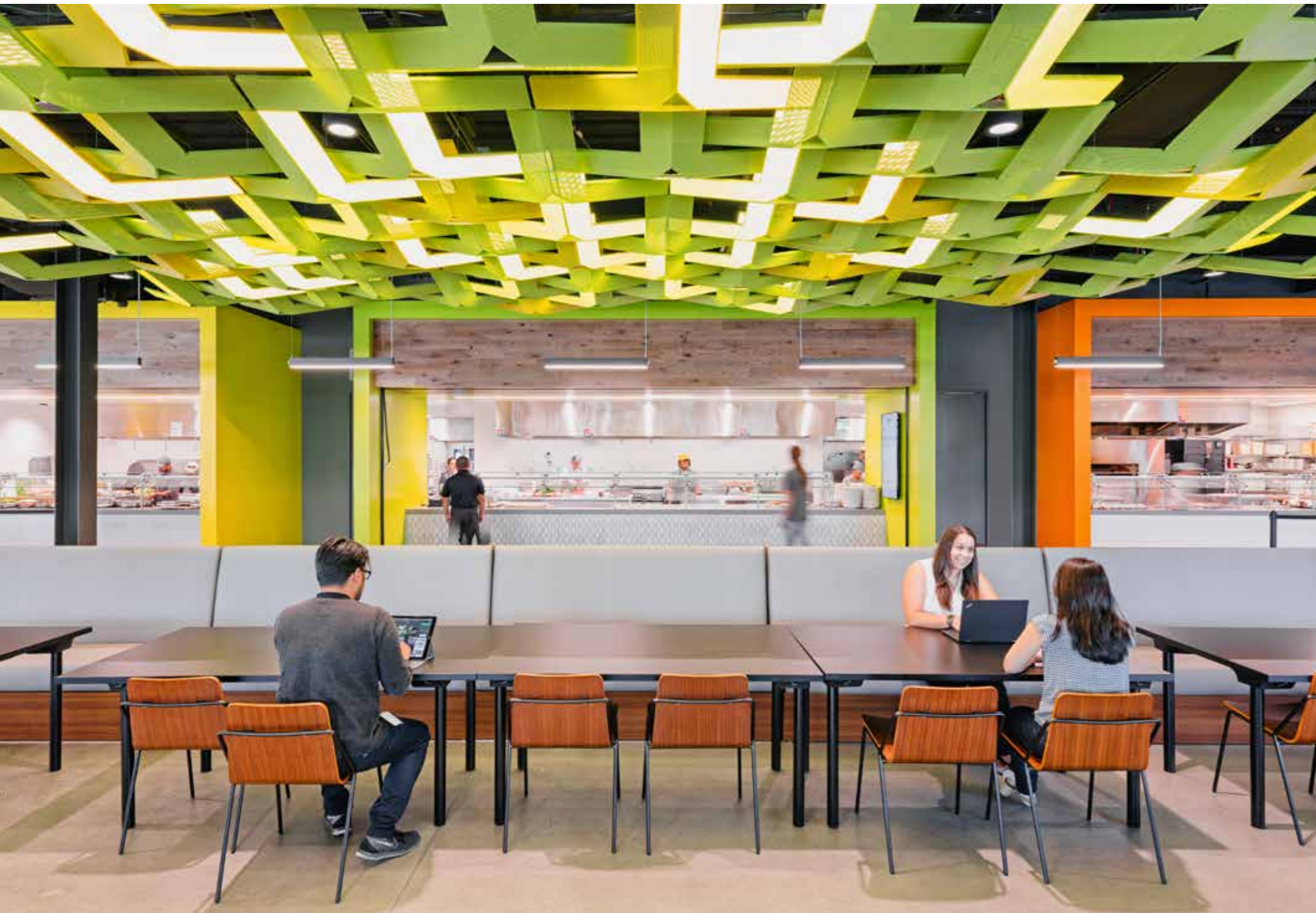



Canopy

Using a canopy is the greatest way to showcase Graypants lighting products. The canopy refers to a powder coated, metal plate that allows us to group multiple pendant lights into endless clustered configurations. Whether it is a cascading array of Roest pendants, or a large grouping of Scraplights Moons in various dimensions, canopy clusters have a dramatic visual impact. Akin to sculpture, using a canopy allows us to create composition where the lights work together to create an artistic element in a space versus using singular lit elements.

We offer canopies in either circular or rectangular configurations, and in various sizes therein. Incredibly versatile, the canopy can be mounted flush or suspended, and hung together in multiples to cover large areas.

We have numerous standard configurations, and can also create something totally custom to fit any space. Using a canopy can truly showcase the strength of the artistic capabilities of Graypants. We enjoy working closely with our designers and customers to create something meaningful that will be appreciated for a lifetime. Whether creating an exceptionally beautiful moment in your dining room, or over a staircase in a commercial space, the uses and expressions are endless.



Canopy Circular

Colors

Black

Custom colors available

Dimensions

Side

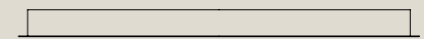

36 x 36 x 2.6 (in)
91 x 91 x 6.6 (cm)

Top

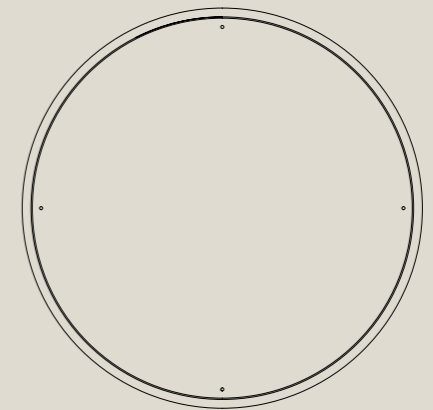

Circle Canopy Configurations

Moon 5
Single circular canopy
5 pendants
1.5m drop

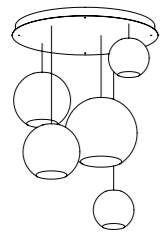

Ausi 5
Single circular canopy
5 pendants
1.5m drop

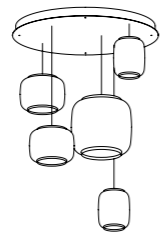

Hive/Nest 5
Single circular canopy
5 pendants
1.5m drop



Drop 5
Single circular canopy
5 pendants
1.5m drop

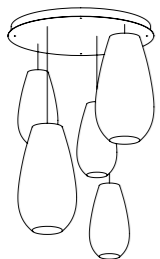

Disc 5
Single circular canopy
5 pendants
1.5m drop

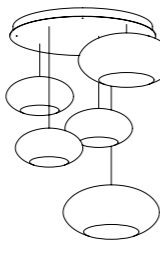

Bell 5
Single circular canopy
5 pendants
1.5m drop

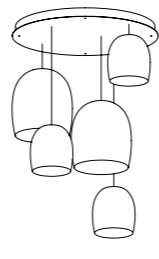

Pebble 5
Single circular canopy
5 pendants
1.5m drop

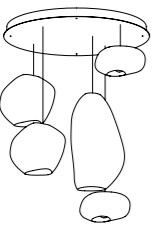

Chrona 5
Single circular canopy
5 pendants
1.5m drop

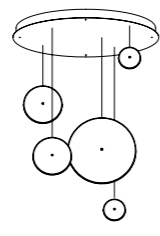

Roest 5
Single circular canopy
5 pendants
1.5m drop

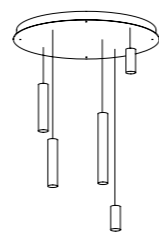

Moon 11
Single circular canopy
11 pendants
3m drop

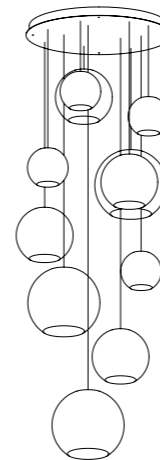

Ausi 11
Single circular canopy
11 pendants
3m drop

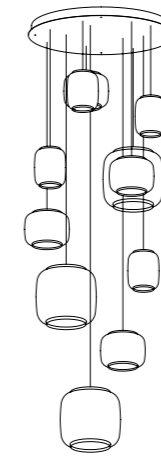

Hive/Nest 11
Single circular canopy
11 pendants
3m drop

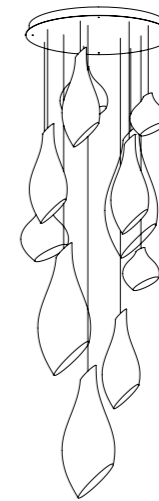

Drop 11
Single circular canopy
11 pendants
3m drop

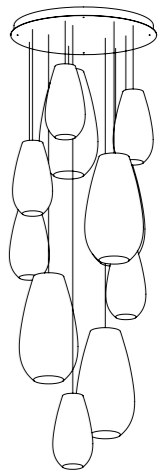

Bell 11
Single circular canopy
11 pendants
3m drop

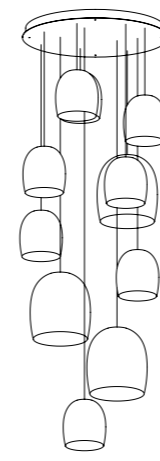

Pebble 11
Single circular canopy
11 pendants
3m drop

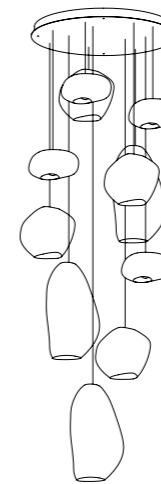

Chrona 11
Single circular canopy
11 pendants
3m drop

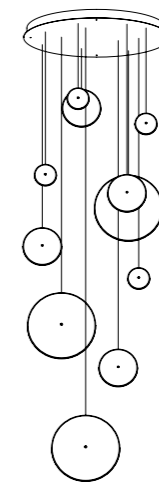

Roest 11
Single circular canopy
11 pendants
3m drop

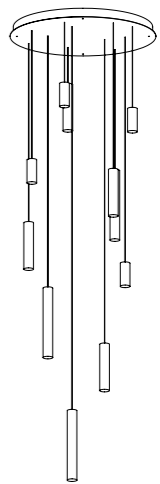



& Rectangular

Colors

Black
Custom colors available

Dimensions

Rectangle
Side

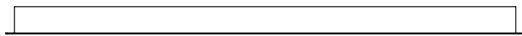

23.2 x 46.5 x 2.6 (in)
59 x 118 x 6.6 (cm)

Rectangle
Top

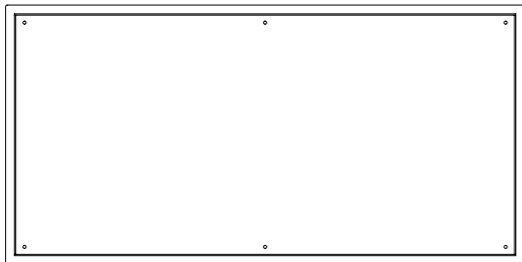

Linear
Top

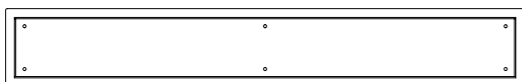

7 x 46.5 x 2.6 (in)
18 x 118 x 6.6 (cm)



Rectangular Canopy Configurations

Scraplights Mix 14

Single rectangular canopy
14 pendants
2.5m drop

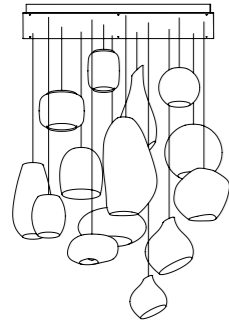

Moon 7

Single rectangular canopy
7 pendants
2.5m drop

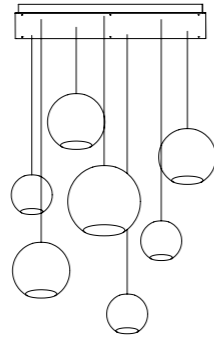

Ausi 7

Single rectangular canopy
7 pendants
2.5m drop

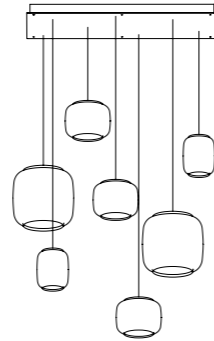

Hive/Nest 7

Single rectangular canopy
7 pendants
2.5m drop

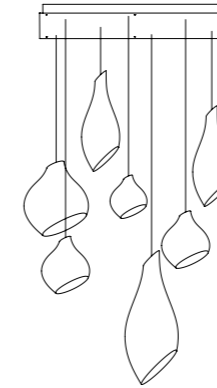

Chrona 7

Single rectangular canopy
7 pendants
2.5m drop

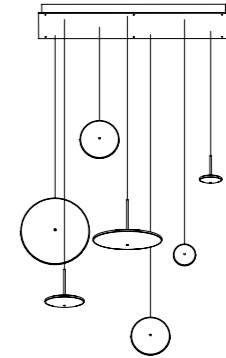

Drop 7

Single rectangular canopy
7 pendants
2.5m drop

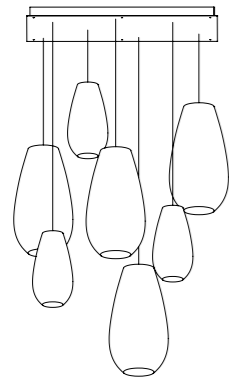

Disc 7

Single rectangular canopy
7 pendants
2.5m drop

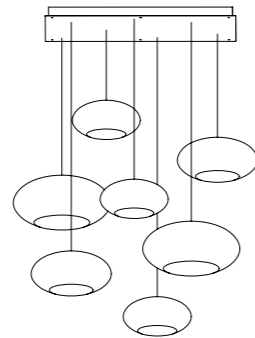

Bell 7

Single rectangular canopy
7 pendants
2.5m drop

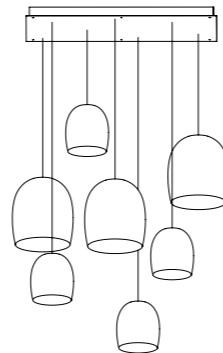

Pebble 7

Single rectangular canopy
7 pendants
2.5m drop

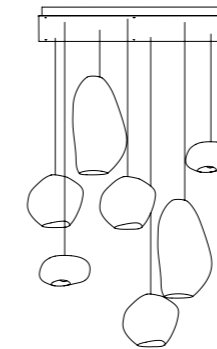

Roest 14

Single rectangular canopy
14 pendants
2.5m drop

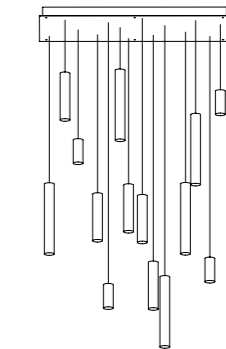

Cable-suspended

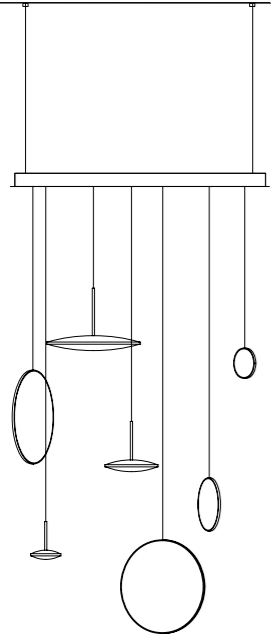

Flush-mounted

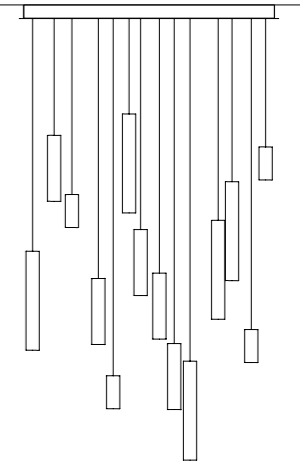

Arch itecture

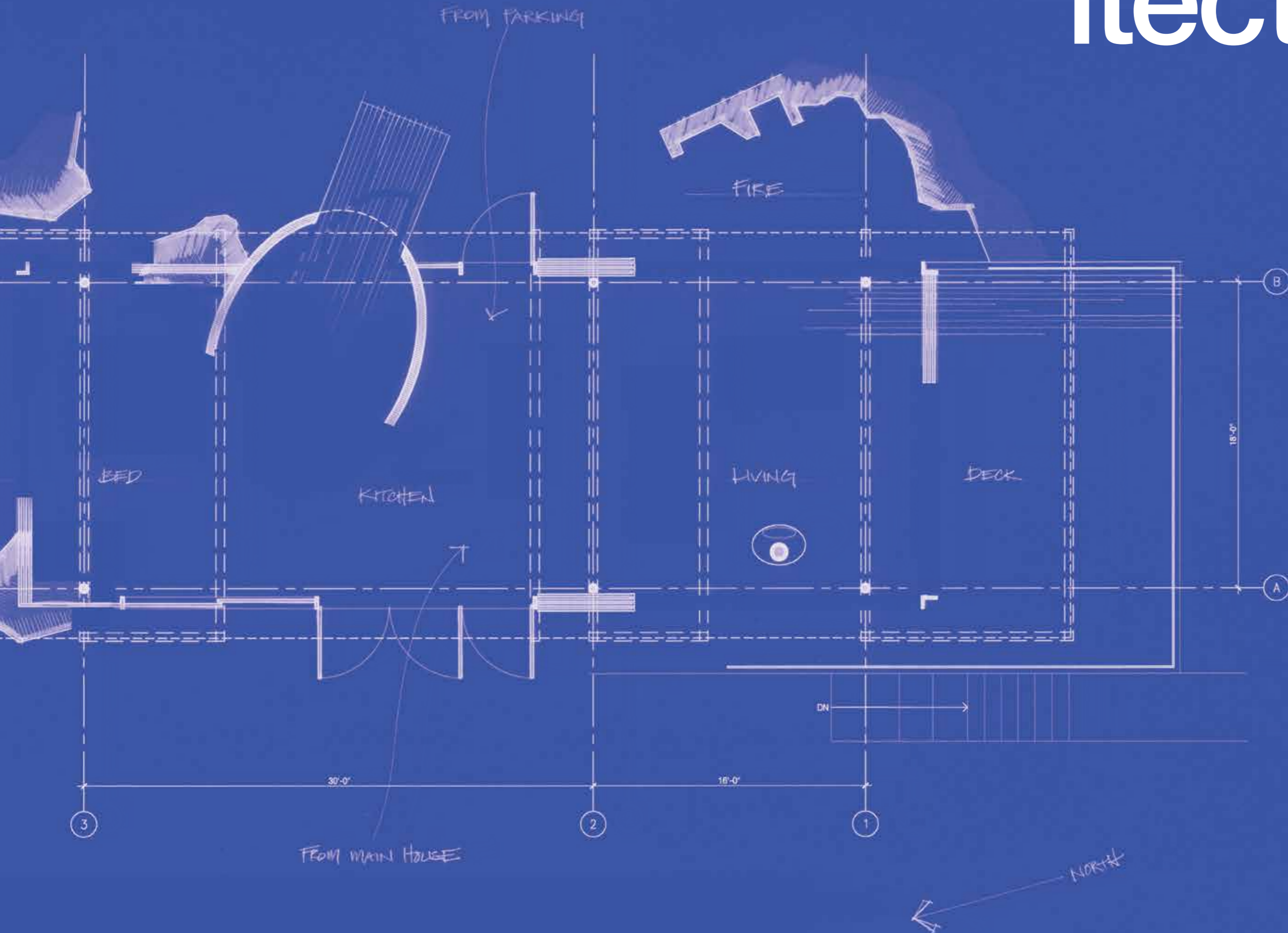

Garage





The distinction between lighting and architecture is, in a sense, a nonsensical one—we undeniably experience architecture via lighting, and lighting via architecture. Pushing this concept, Graypants framed its debut architectural project, The Garage, as a lantern—architecture as lighting.

Originally a dilapidated garage from the post world war II era, the project set out to update the structure's use as a residential cabin that preserved the intricacies and stories of the old construction. Contemporary elements have been skillfully mixed in with the old to give each piece a second life and in turn a renewed function in the space.

The aged wooden floor is oriented to bring the eye out towards the water, revealing hidden beds that fold out into seats. A folding glass wall lifts to extend the usable space of the cabin onto the adjacent pebbled patio that forms the base for the structure. By exposing the square frame wide flange that supports the cabin, and illuminating the member from within the web, the cabin seems to almost float above the ground.

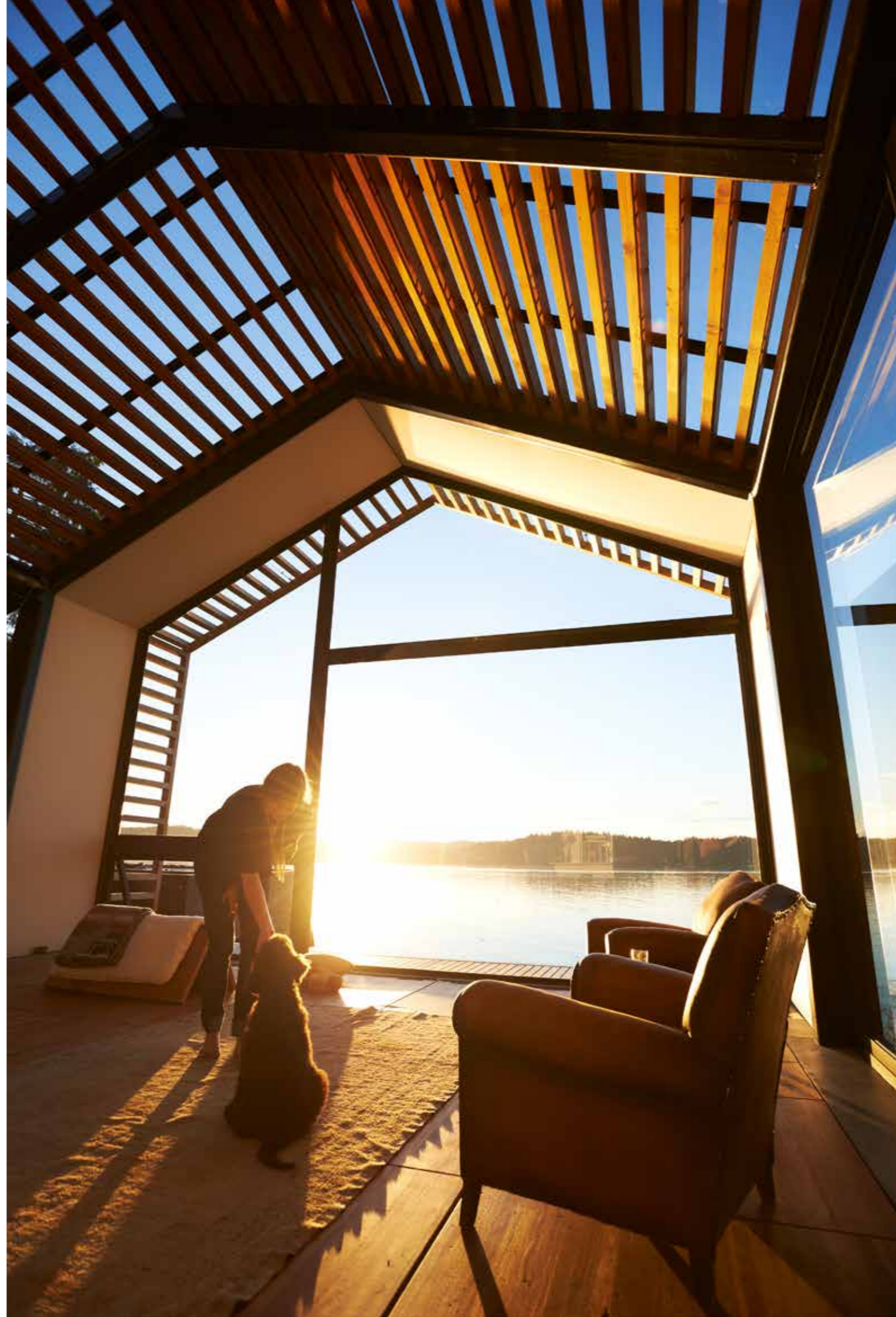
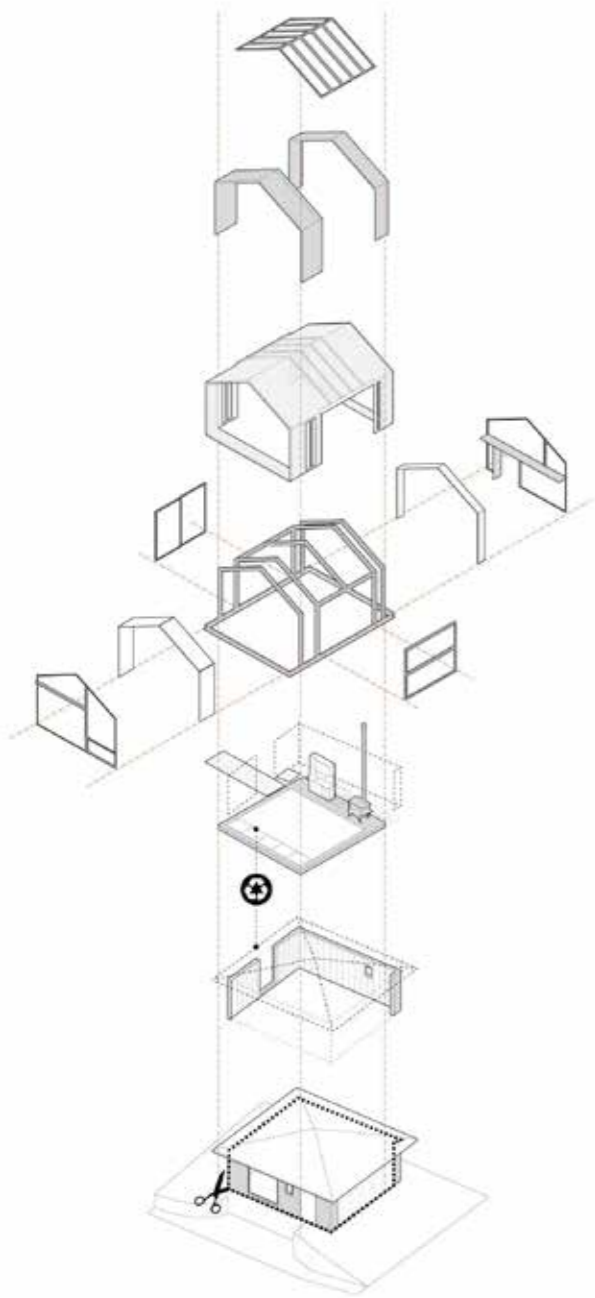



Halo

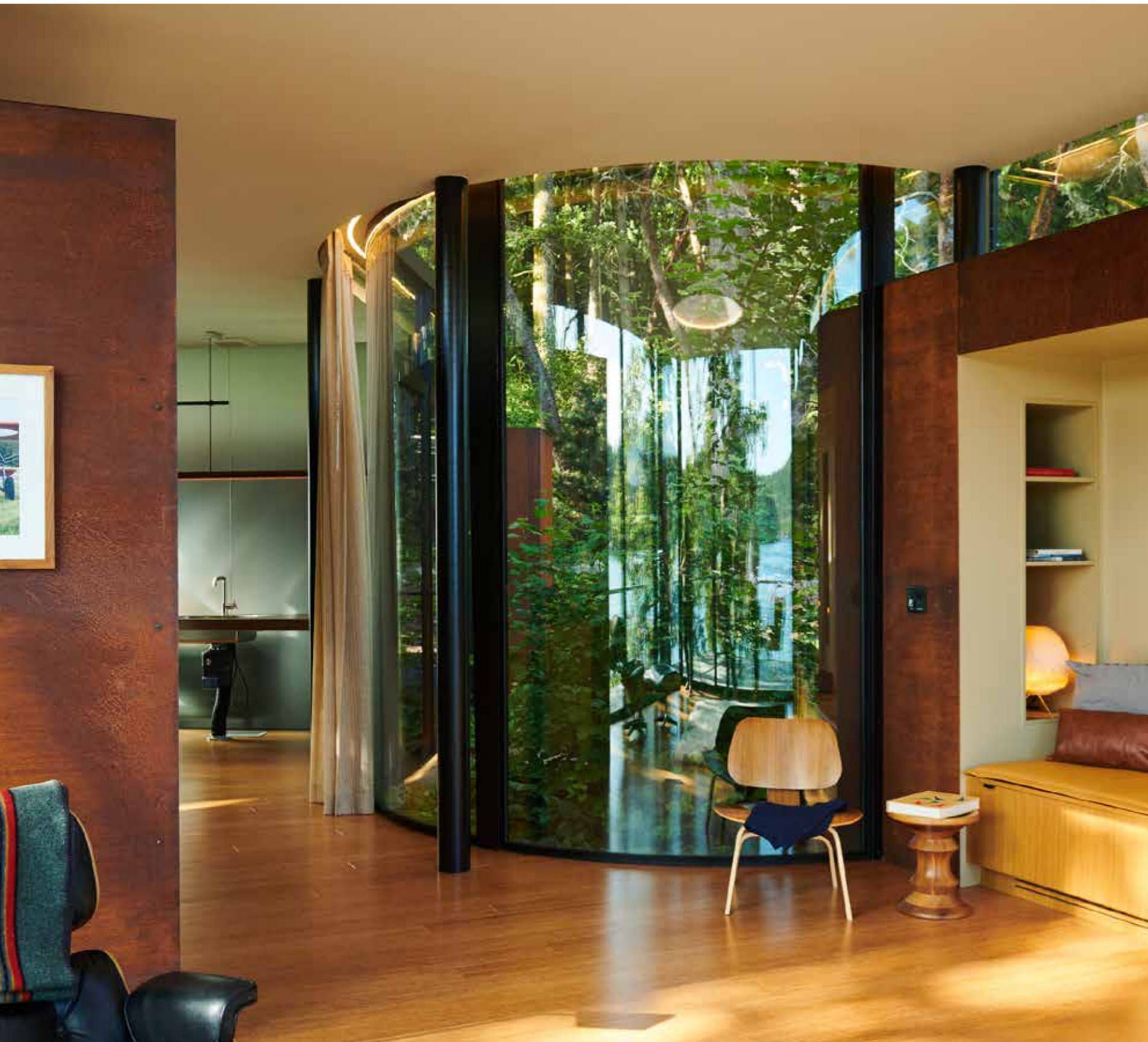

Halo is a restrained yet playful architectural project designed by Graypants on the shores of one of Washington State's San Juan Islands.. Strict parameters maintained by the zoning code were reimagined as opportunities to be creative and maximize the existing unique but small footprint.

Halo was initially conceived of as a home office, but as the client used the realized space, it gradually became a personal retreat. For the homeowner, this meant a slower pace and an openness to more reflection—Halo became an anchor for that transformation—a spiritual work space that is monastic without being religious.

An exploration of building-as-light, Halo blurs the lines between nature and structure. Honoring the site, the design responds directly to the landscape, creating a sense that Halo has been there for a long time. Surrounding landscaping welcomes and touches Halo, reaching up to the edges of the steel and glass. The small space attempts to maximize the experience—not of itself, but of the place: the nature, the light, the water.

Halo contains surprisingly few prominent fixtures in an attempt to allow the building itself to become the central fixture. A circular, domed skylight creates an anchoring center, offering connection to Halo's surroundings from five sides—bringing in natural light during the day, and sending a warm, haloed glow into the trees at night.

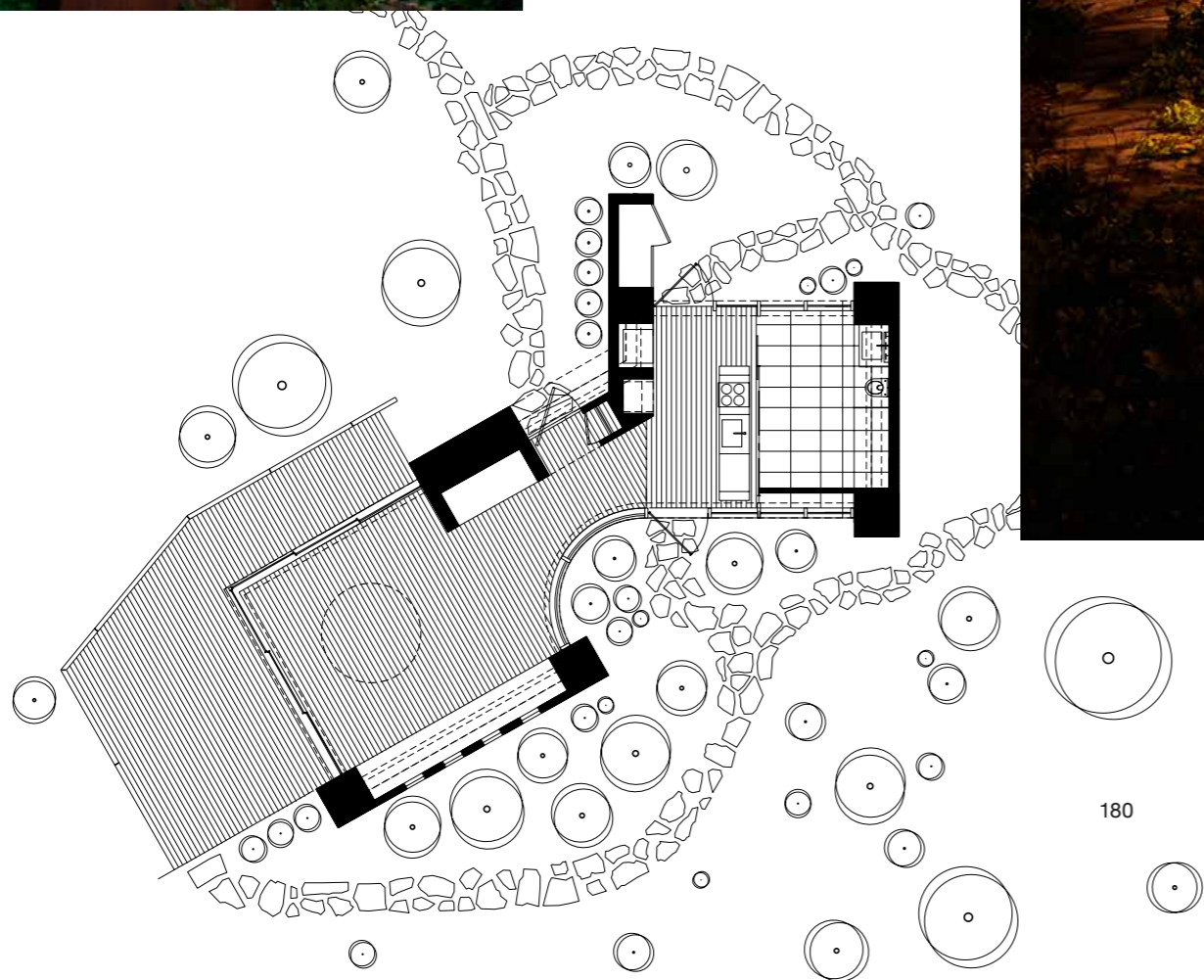

180

181

Tomo



The client named the restaurant Tomo after his grandmother, Tomoko, and the Japanese “tomodachi”, meaning ‘friend’. Friendship and familial connection is a throughline in how the restaurant approaches both its service and its place in a developing area south of Seattle.

Wood is a centerpiece of the space—referencing shou sugi ban, much of the interior wood has been stained a deep ebony. Oak shingles arranged like scales clad a wall running the length of the space, and contrast the strict geometry of the vertical ash slats that wrap the opposing walls. The mingling of wood throughout the space creates an understated, monochrome texture—the architecture aims to be demure and humble, letting the food be the center of the experience.

Nearly all of the lighting was directly integrated into the architectural elements—the wall panels, the bench seating, the bar shelves—the lighting is felt but not seen. The exception is an 80-foot linear fixture that traces the entire length of the restaurant.

Using local materials and manufacturing in nearly every aspect of the design - the craftsmanship, the wood - was intentional in bringing down the carbon footprint of the project.

Since opening, the restaurant has immediately begun outperforming their projections, with a booked out calendar bringing hundreds of people to the neighborhood every single evening, and a rolling waitlist topping a thousand eager diners.

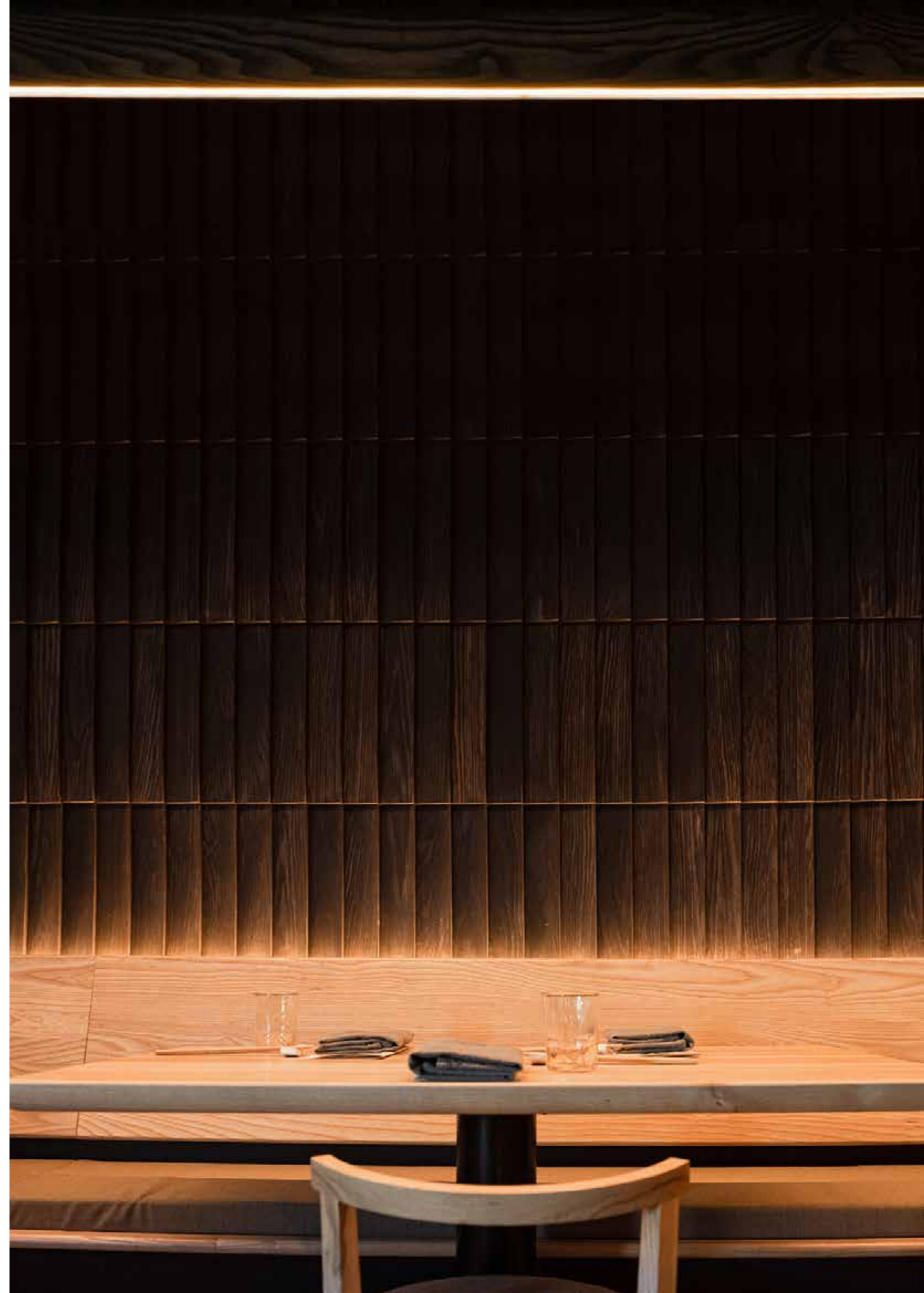

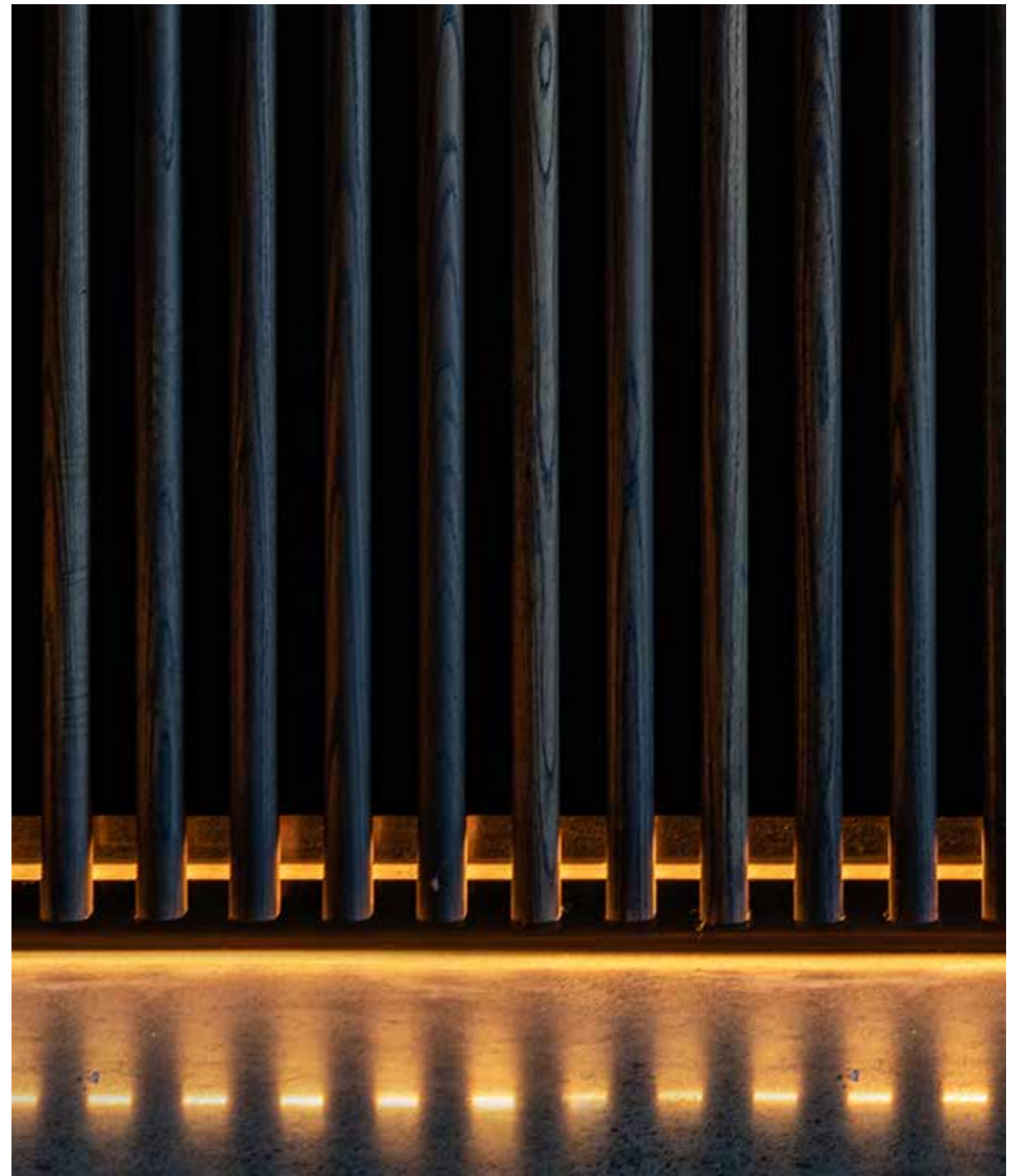

Seattle

3220 1st. Ave. S. Suite 400
Seattle, WA 98134
(206) 420-3912
seattle@graypants.com

Amsterdam

Meeuwenlaan 126B,
1021JN Amsterdam
+31 (0) 20 820 8990
amsterdam@graypants.com

Dream big.
Scribble often.
Make thoughtfully.