

HERITAGE

— COLLECTION —

DARK

Shaping the future with **HERITAGE**

HERITAGE
— COLLECTION —

P 4

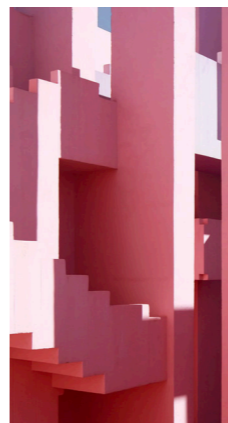

RICARDO
BOFILL

P 10



LÉON
STYNEN

P 14



LUC
VINCENT

P 18



PIERRE
VASARELY

RICARDO BOFILL

Taller de arquitectura

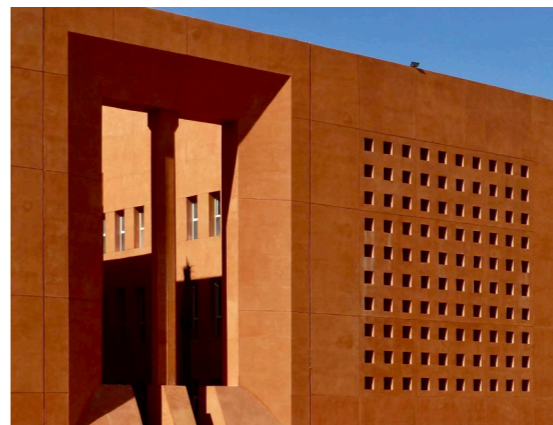
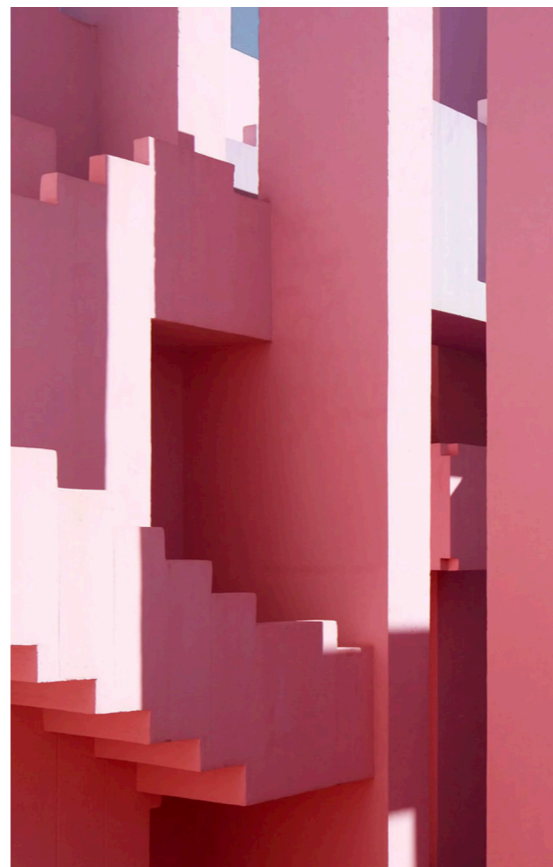



2014
AGUJA

HERITAGE
COLLECTION

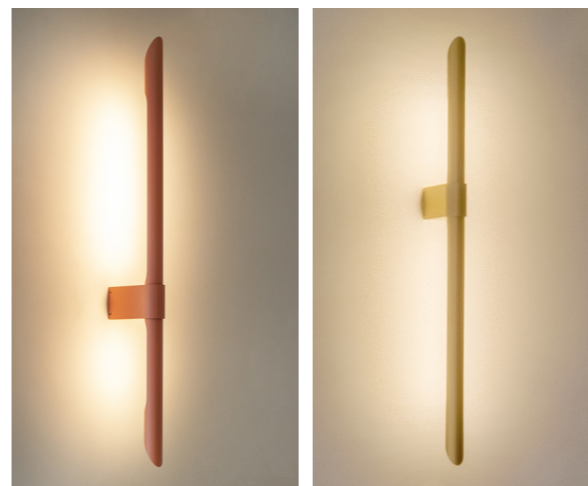

| | | | |
|-------|-------------------|-----|--|
| BB(B) | COLORS | 02 | Black |
| | | 03 | White |
| | | 111 | Brass Finish |
| E | CRI • LUMENOUTPUT | 3 | AGUJA 115 >90CRI • 3150 Lm / 19,4W / 3000K |
| | | | AGUJA 170 >90CRI • 5250 Lm / 32,6W / 3000K |
| | | | AGUJA 300 >90CRI • 6300 Lm / 38,8W / 3000K |
| K | DRIVER | 1 | No driver |
| | | 0 | Non dimmable (intern) |
| | | 2 | Dimmable 1-10 V (extern) |
| | | 3 | Dali (extern) |

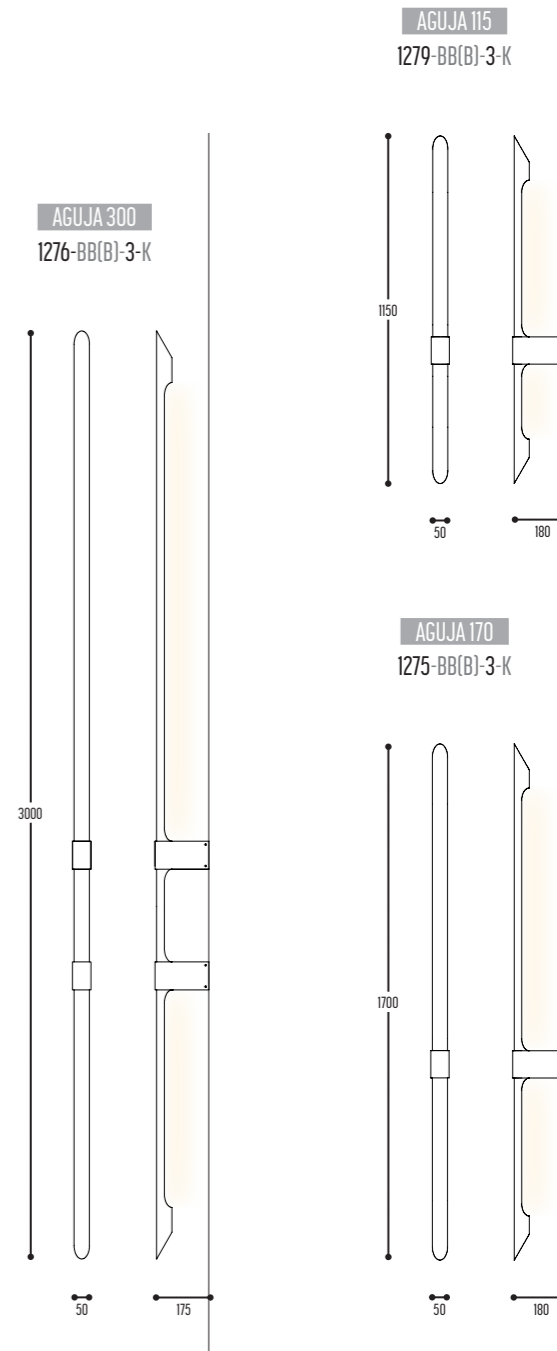



1989
SWIFT BUILDING
 La Hulpe - Belgium

HERITAGE
 COLLECTION

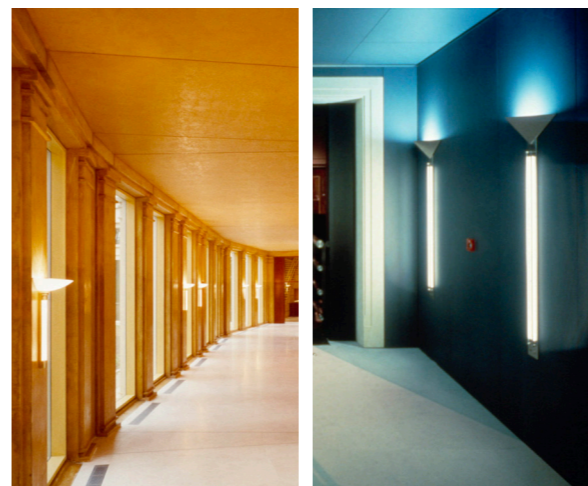

| | | | |
|-------|--------|-----|---|
| BB(B) | COLORS | 02 | Black |
| | | 03 | White |
| | | 110 | Brass |
| C | RBA 1 | 2 | >90 CRI • 600-800 Lm / 15-25 W / 2700 K |
| | | 3 | >90 CRI • 600-800 Lm / 15-25 W / 3000 K |
| | RBA 2 | 2 | >90 CRI • 800 Lm / 25 W / 2700 K |
| | | 3 | >90 CRI • 800 Lm / 25 W / 3000 K |
| | RBA 3 | 2 | >90 CRI • 1600 Lm / 50 W / 2700 K |
| | | 3 | >90 CRI • 1600 Lm / 50 W / 3000 K |
| K | DRIVER | 1 | No driver |
| | | 0 | Non dimmable (intern) |
| | | 2 | Dimmable 1-10 V (intern) |
| | | 3 | Dali (intern) |

Alu-Metal

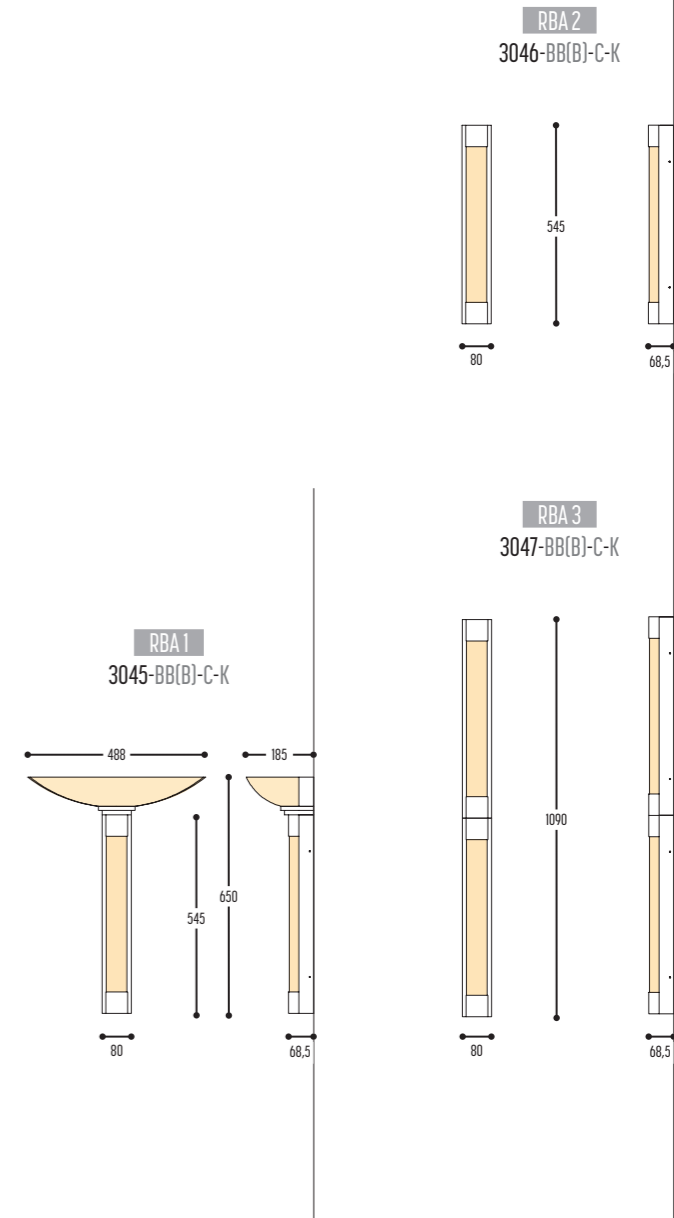

LÉON STYNEN

Architect



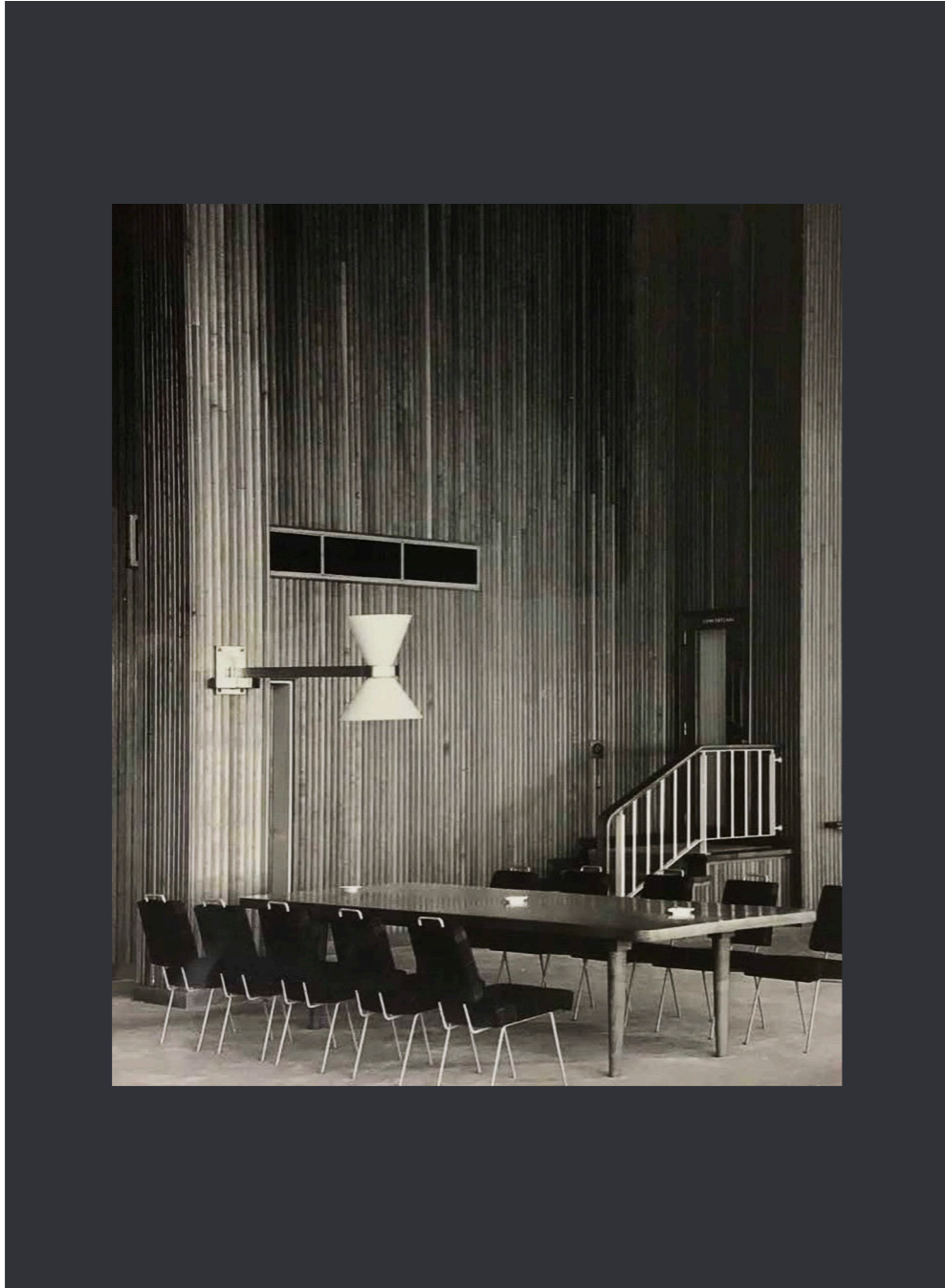

1953
KURSAAL
Oostende - Belgium

HERITAGE
COLLECTION

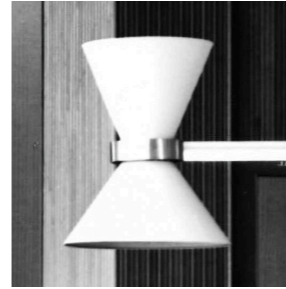

| | | | | |
|-------|-------------------|-----|-----|--|
| BB(B) | COLORS CONES | 02 | | Black |
| | | 03 | | White |
| | | 101 | | Soft Pink |
| | | 103 | | Soft Blue |
| | | 104 | | Soft Green |
| | | 124 | | Kaki |
| | | 140 | | Old Pink |
| | | 141 | | Terracotta Red |
| | | 142 | | Oxide Red |
| | | | | |
| EFF | CRI • LUMENOUTPUT | 904 | LED | >90 CRI • 2x 600 Lm / 350 mA / 2x 6,4 W |
| | | 914 | LED | >90 CRI • 2x 1400 Lm / 350 mA / 2x 14 W |
| H | COLOR TEMP | 2 | | 2700 K |
| | | 3 | | 3000 K |
| DD | SUSP. CABLE | 01 | | 1,5 m |
| | | 02 | | 2,5 m |
| K | DRIVER | 1 | | No driver |
| | | 0 | | Non dimmable (intern) |
| | | 2 | | Dimmable 1-10 V (intern) Small version (extern) |
| | | 3 | | Dali (intern) Small version (extern) |
| | | 4 | | Phase cut (intern) |

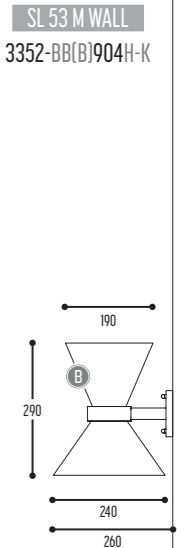
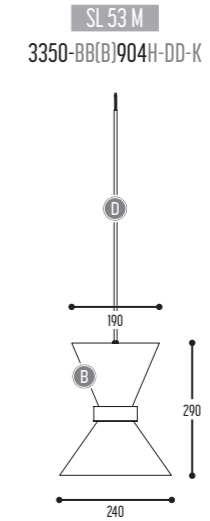
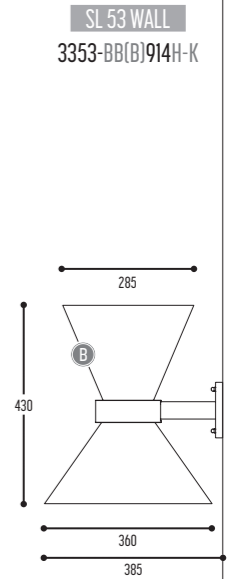
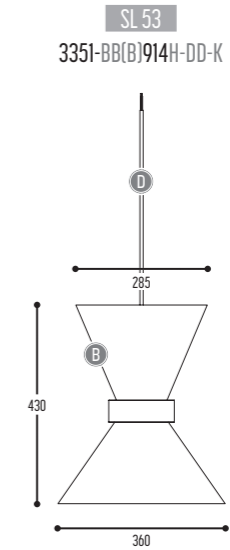

LUC VINCENT

Square Man

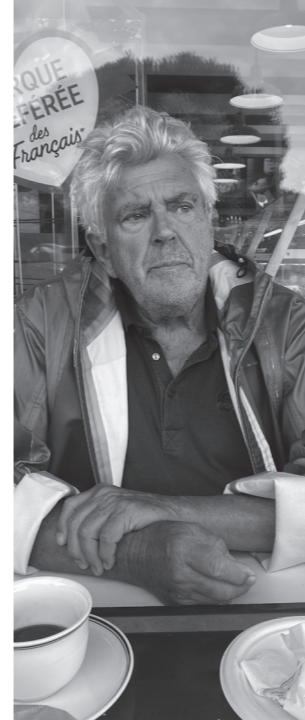



1996
SQUARE MOON

HERITAGE
COLLECTION

| | | | |
|-------|-------------|-----|--------------------------------------|
| BB(B) | COLORS | 02 | Black |
| | | 03 | White |
| | | 149 | Alu Brushed |
| | | 151 | Bronze Dark |
| FF | LED | 14 | >80 CRI • 675 Lm/m / 9,6 W/m - 14W |
| | | 22 | >90 CRI • 1050 Lm/m / 14,4 W/m - 22W |
| | | 43 | >90 CRI • 2100 Lm/m / 28,8W/m - 43W |
| H | COLOR TEMP. | 2 | 2700 K |
| | | 3 | 3000 K |
| | | 4 | 4000 K |
| II | PLEXI | 03 | White |
| | | 04 | Red |
| | | 06 | Blue |
| | | 08 | Orange |
| DD | SUSP. CABLE | 00 | N.A. |
| | | 02 | 1,5m |
| | | 03 | 2,5m |
| K | DRIVER | 1 | No driver |
| | | 0 | Non dimmable (intern) |
| | | 2 | Dimmable 1-10 V (intern) |
| | | 3 | Dali (intern) |



SQUARE MOON
3400-BB(B)-FFH-00-II-K

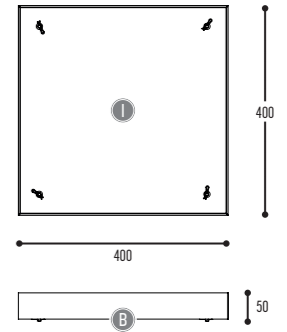

SQUARE MOON S
3401-BB(B)-FFH-DD-II-K (DOWN)
3402-BB(B)-FFH-DD-II-K (UP/DOWN)

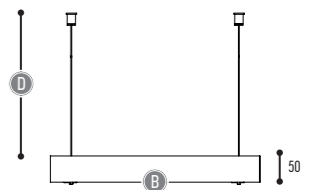
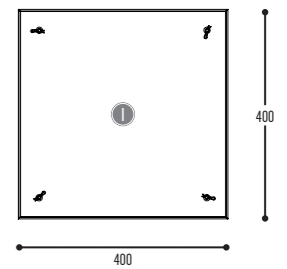

PIERRE VASARELY

Optical Art



DESIGN

Orum, il endion plaut eum reribus iunt quodia dolut que nam ex el il il ipicia dolore, omnihil loritint ma volendicpic temquam quundit pla paria que nansed maio mos et restoremo officis estibus.

Luptatur accptur? Ucid mo coneseque pres et, officte vellam volar rehenis alianem et aut antionserum hil iur saperuptas il illicium sont eatiaer umquatur, autae labo. Musanitia del ipisi beria dit faciiscid excea dolo cum faccuscipis sus enienim

Tia eassim dolor rem. Dus, od mi, con cumquam, adiatu, cus nullabo rehent, tem estint magnis quatem re por soluptatum eici inum archil imet etur, ut excearc imaiorum repro volupta tendae doluptaturem este molar apit am, si in cus, ulpa que re valorem reperum qui arumquam, ommoluptae

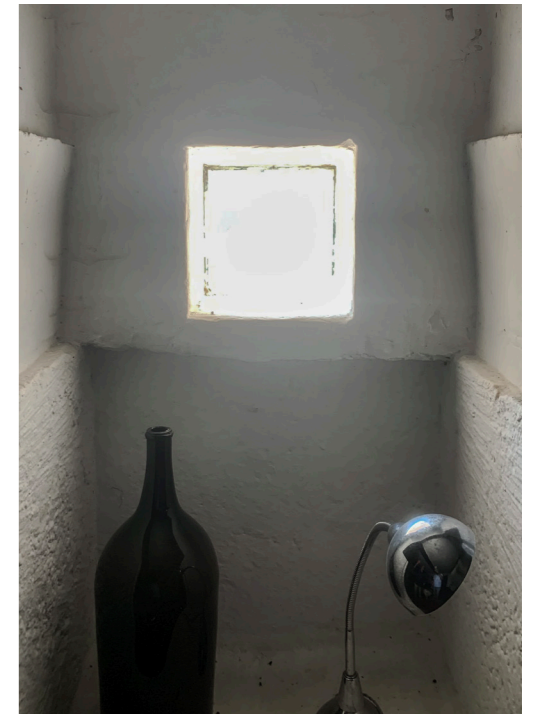



2023
PIERRE VASARELY & LUC VINCENT

HERITAGE
COLLECTION



| | | | |
|-------|-------------------|-----|--------------------------|
| BB(B) | COLORS | 151 | Bronze Dark |
| EFF | CRI • LUMENOUTPUT | 921 | >90 CRI • 14,4 W/m - 21W |
| H | COLOR TEMP. | 2 | 2700 K |
| K | DRIVER | 1 | No driver |
| | | 0 | Non dimmable (intern) |
| | | 2 | Dimmable 1-10 V (intern) |
| | | 3 | Dali (intern) |



VASARELY 1
3425-151-9212-K

VASARELY 4
3428-151-9212-K

VASARELY 2
3426-151-9212-K

VASARELY 5
3429-151-9212-K

VASARELY 3
3427-151-9212-K

VASARELY 6
3430-151-9212-K

DARK